

R290 HEAT PUMP

Service manual

MUAMR-H14 / MUAMR-H14T



CONTENTS

Part 1 General Information 3

Part 2 Component Layout and Refrigerant Circuits..... 5

Part 3 Control and Field Settings..... 18

Part 4 Diagnosis and Troubleshooting 61



Part 1

General Information

1 Product Lineup 4

2 Nomenclature..... 4

1 Product Lineup

Power Supply	220-240V/1N/50Hz							380-415V/3N/50Hz		
Model	MUAMR-04-H14	MUAMR-06-H14	MUAMR-08-H14	MUAMR-10-H14	MUAMR-12-H14	MUAMR-14-H14	MUAMR-16-H14	MUAMR-12-H14T	MUAMR-14-H14T	MUAMR-16-H14T
Appearance										

Note:

Please note that these photos are for reference only, actual products may vary.

2 Nomenclature

MU	A	M	R	-	04	-	H	14	T
1	2	3	4		5		6	7	8

Legend		
No.	Code	Remarks
1	MU	Brand: MundoClima
2	A	Unit type: Aerotherm
3	M	Structure: MonoBlock
4	R	Refrigerant: R290
5	04	Capacity code: 4: 4kW; 6: 6kW; 8: 8 kW; 10: 10 kW; 12: 12 kW; 14: 14 kW; 16: 16 kW;
6	H	Type: Heat Pump
7	14	Series Version: 14
8	T	Power Supply of heat pump R: 3-phase, 380-415V, 50Hz; Omitted: 1-phase, 220-240V, 50Hz

Part 2

Component Layout and Refrigerant Circuits

1 Layout of Functional Components.....	6
2 Piping Diagrams.....	14

1 Layout of Functional Components

1.1 4-6kW

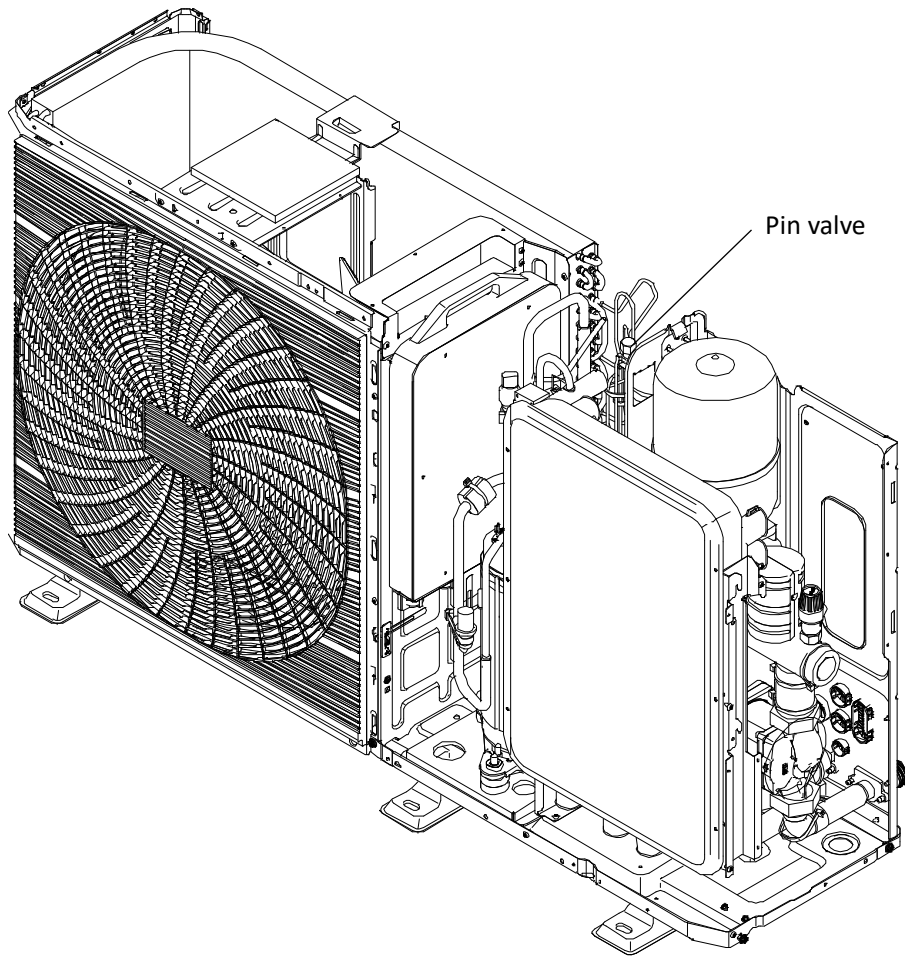

Pin valve

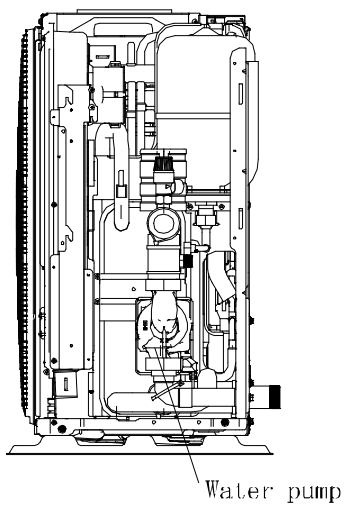

Water pump

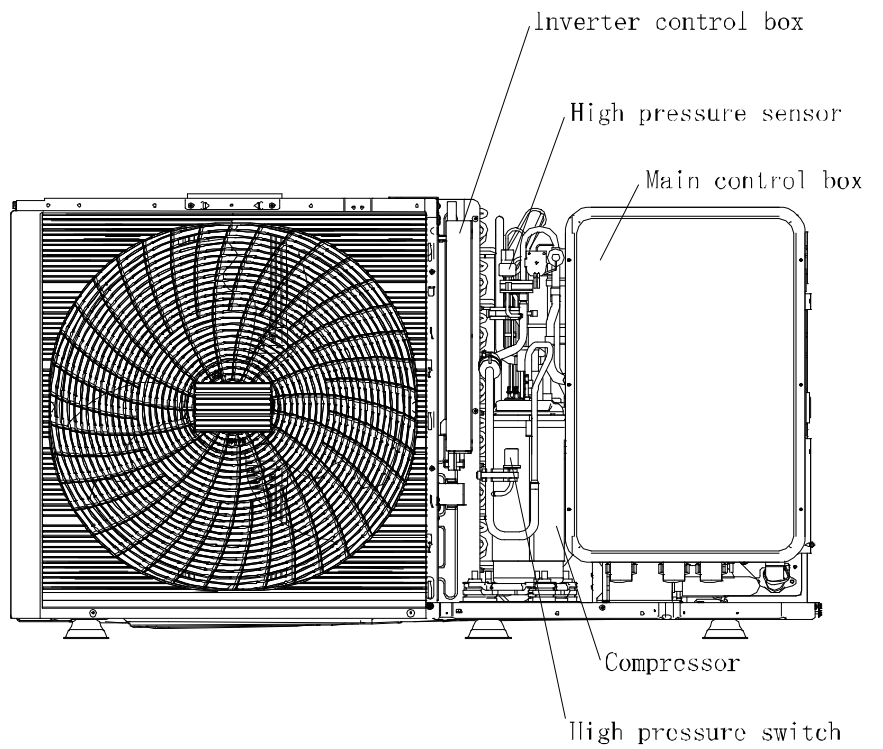

Inverter control box

High pressure sensor

Main control box

Compressor

High pressure switch

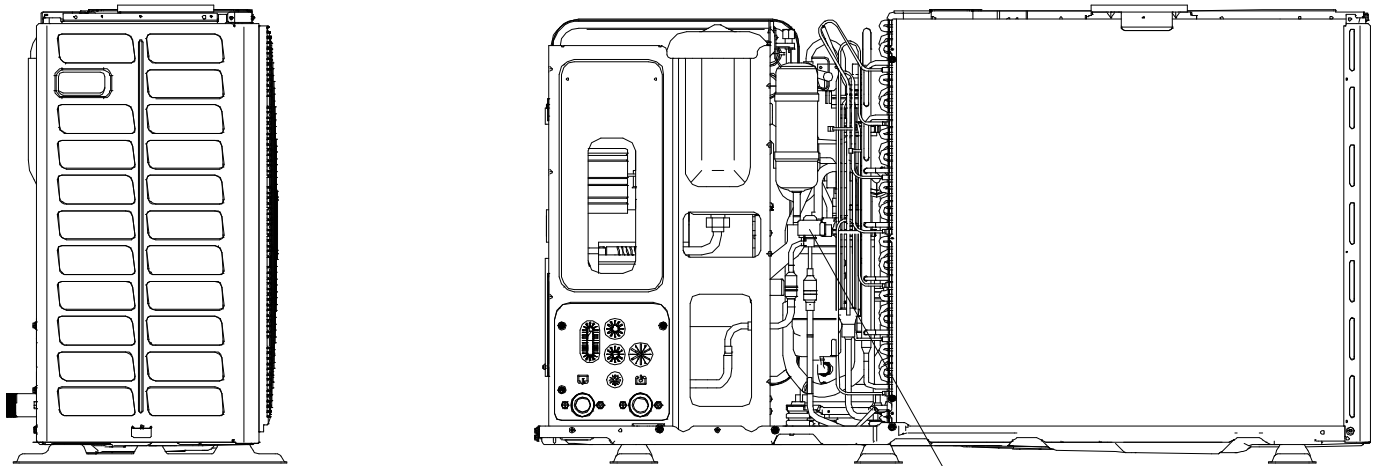

Electronic expansion valve

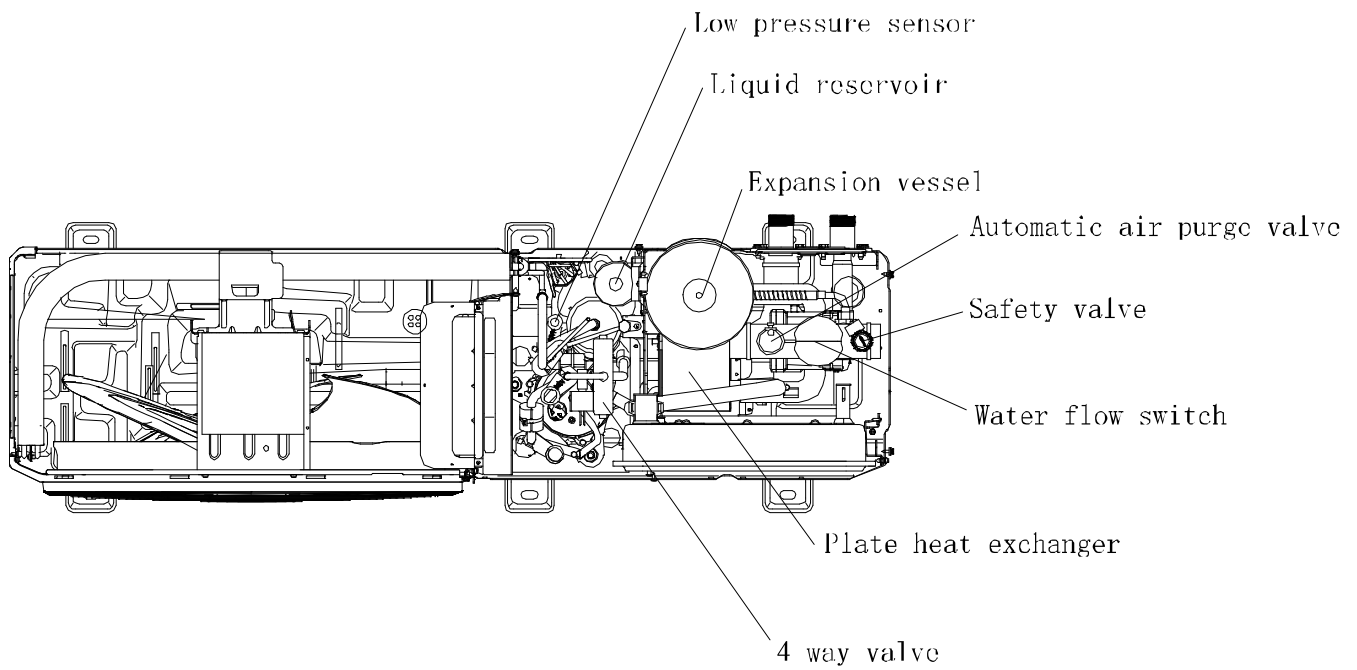

1.2 8-10kW

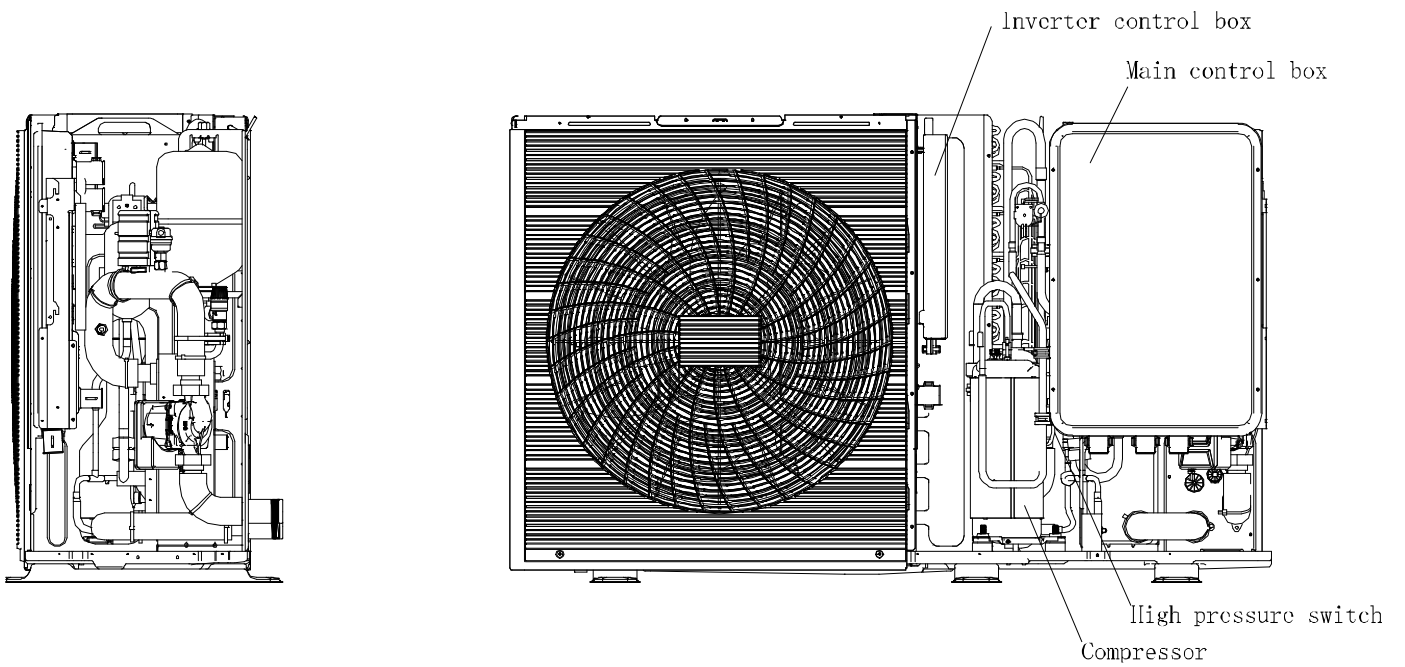
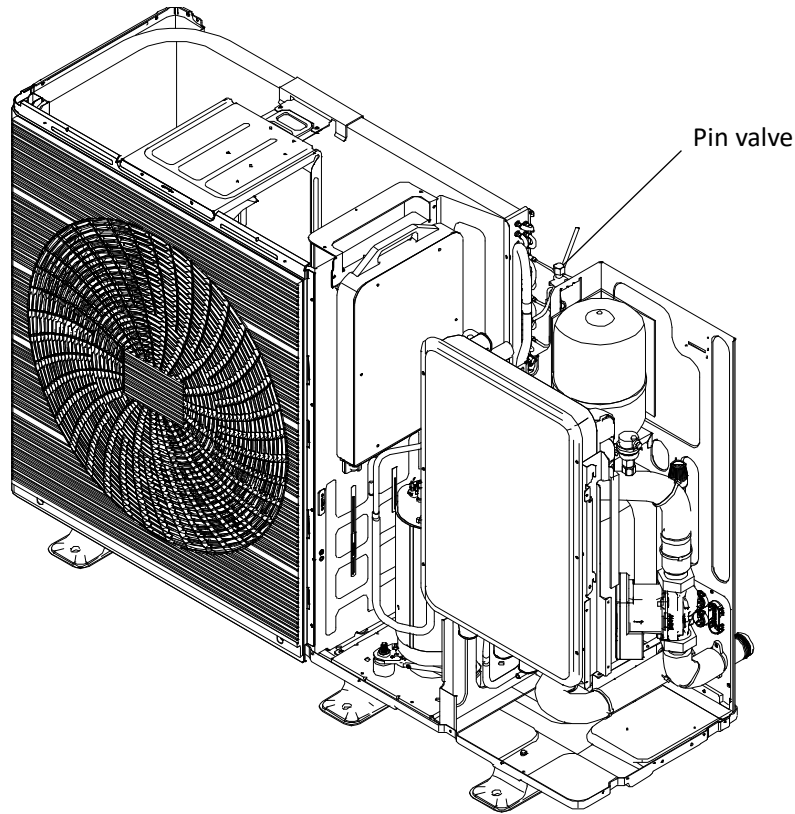

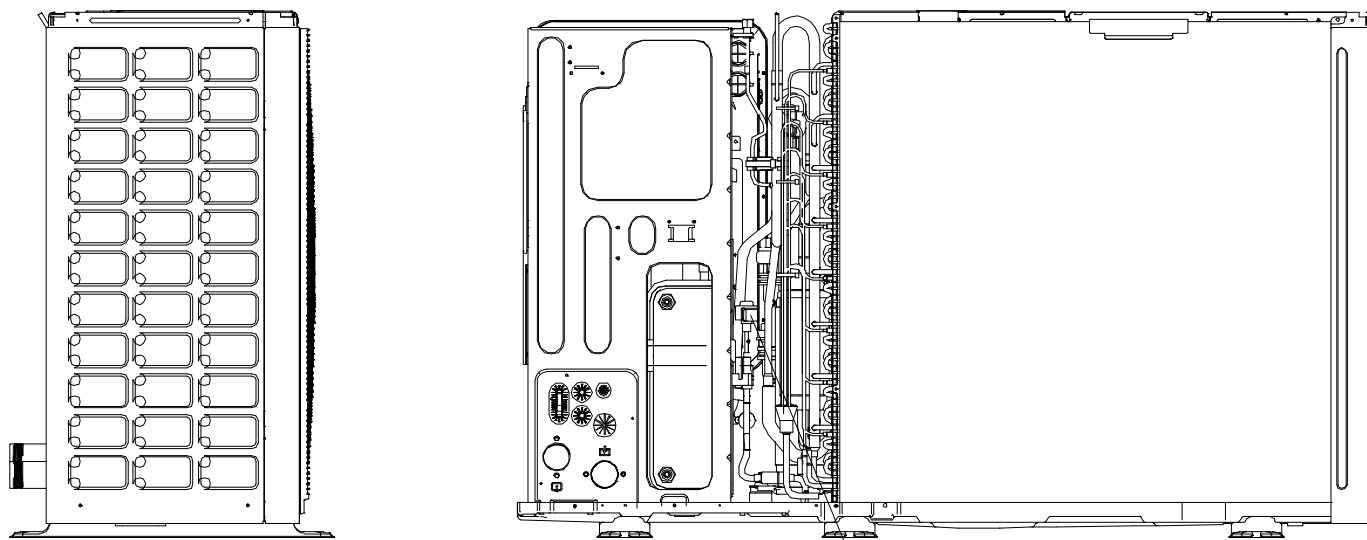

Electronic expansion valve

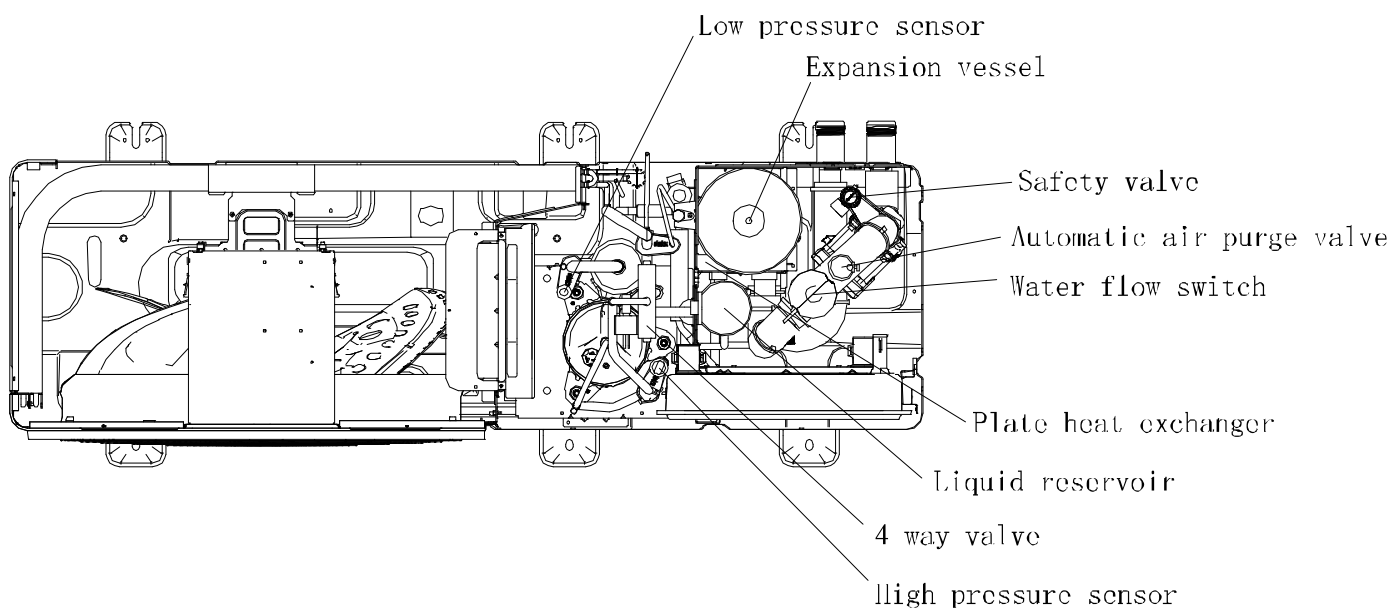

1.3 12-16kW 1Ph

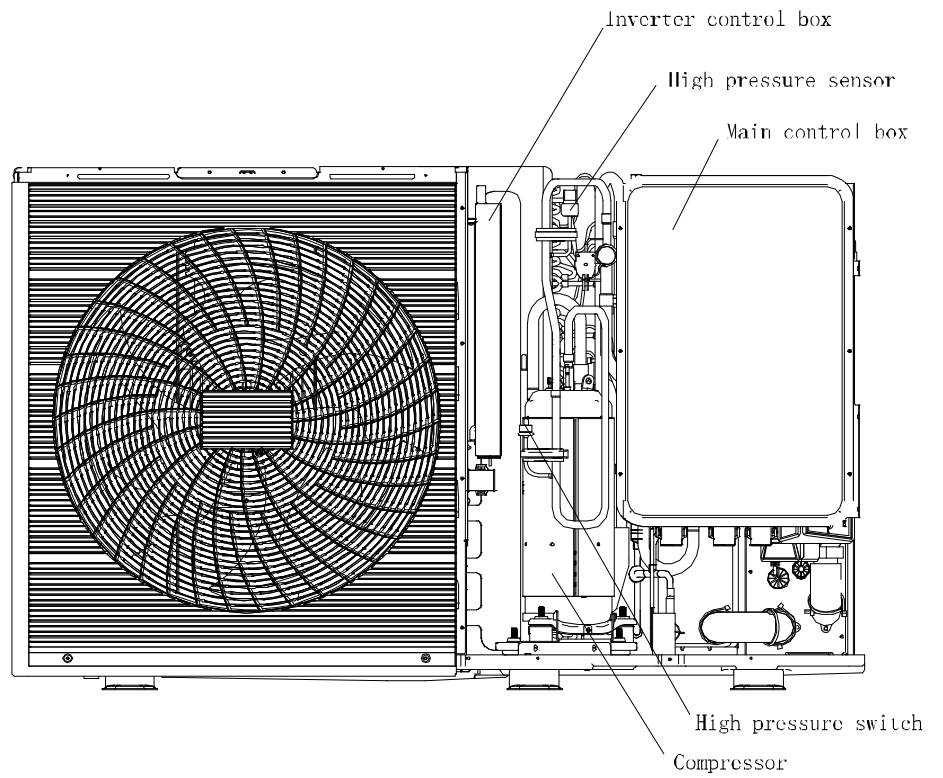
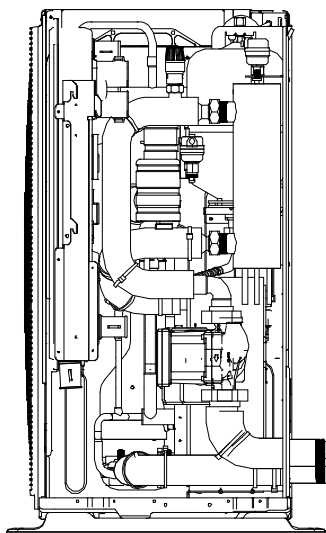
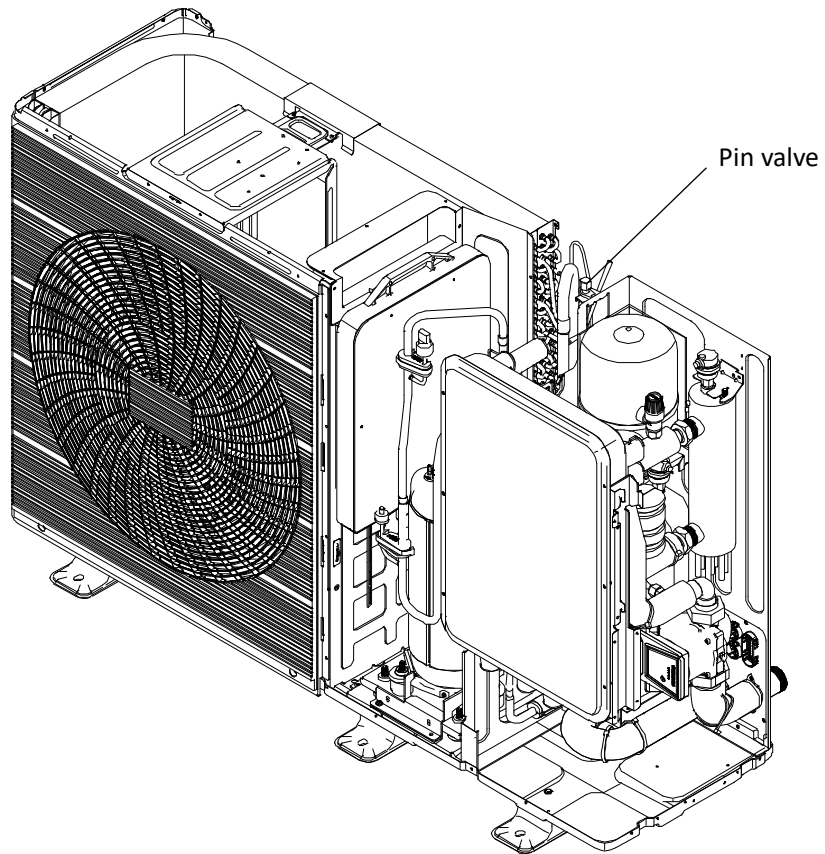

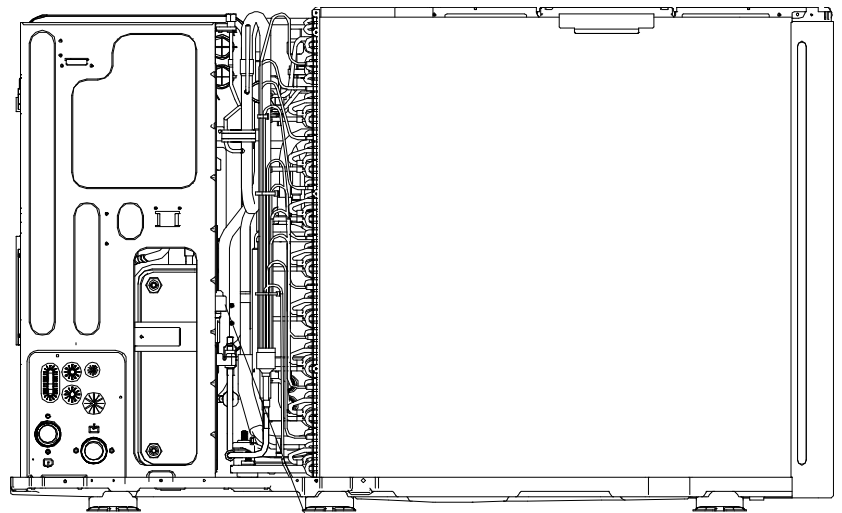
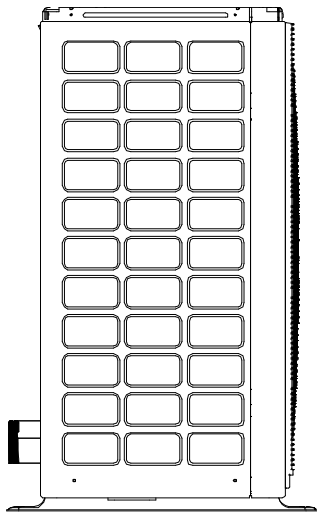

Electronic expansion valve

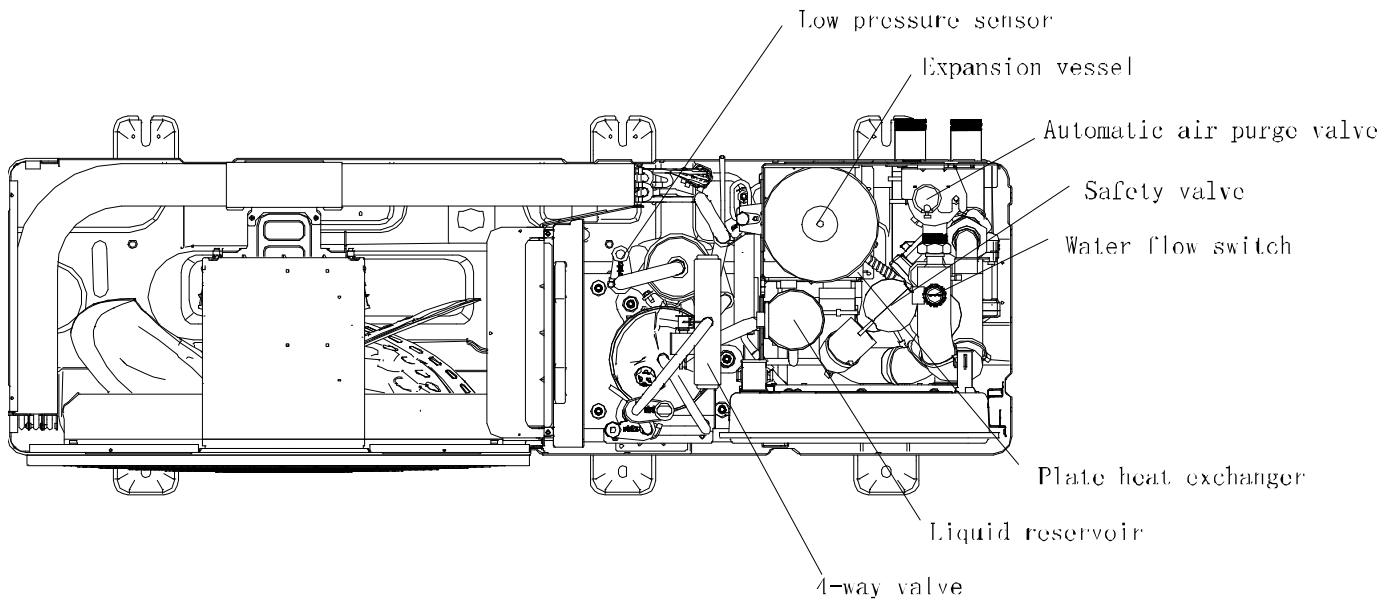

1.4 12-16kW 3Ph

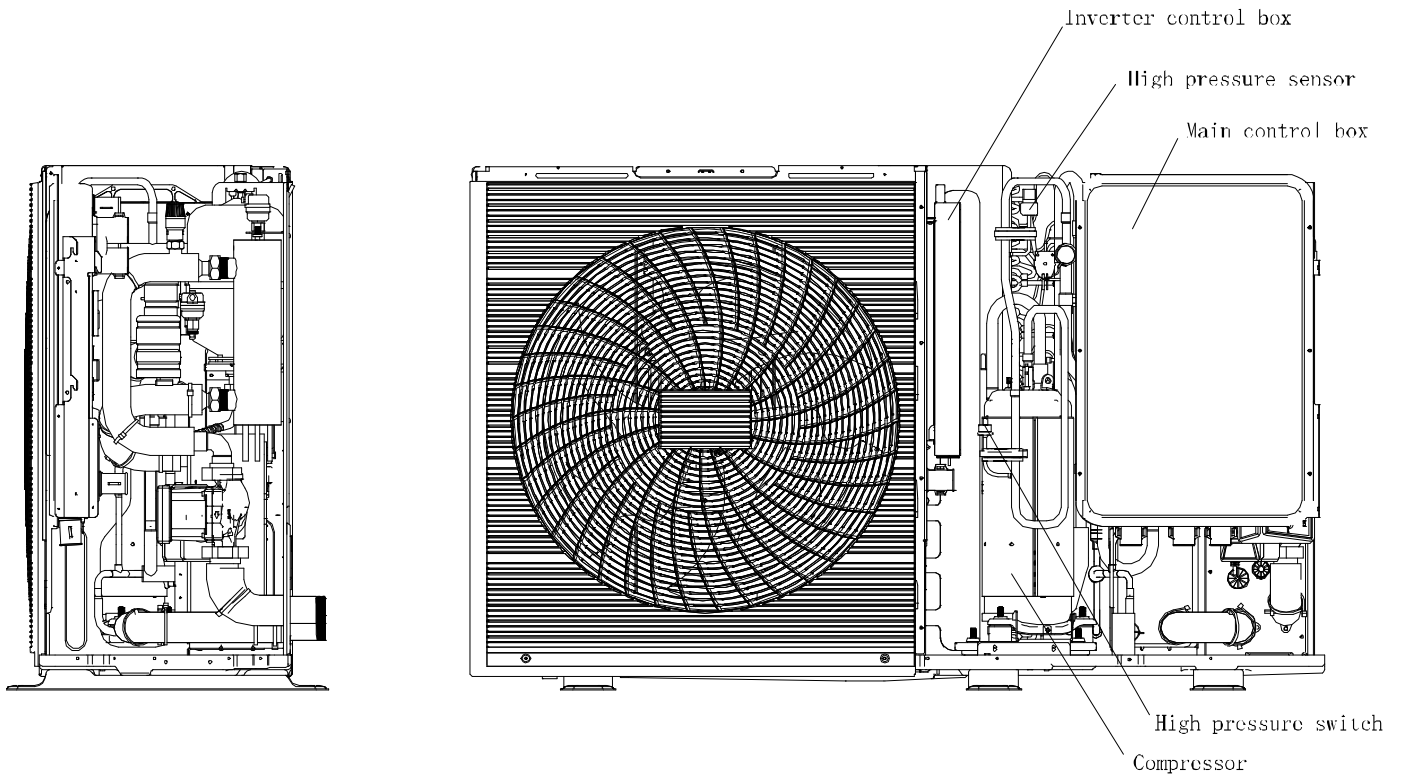
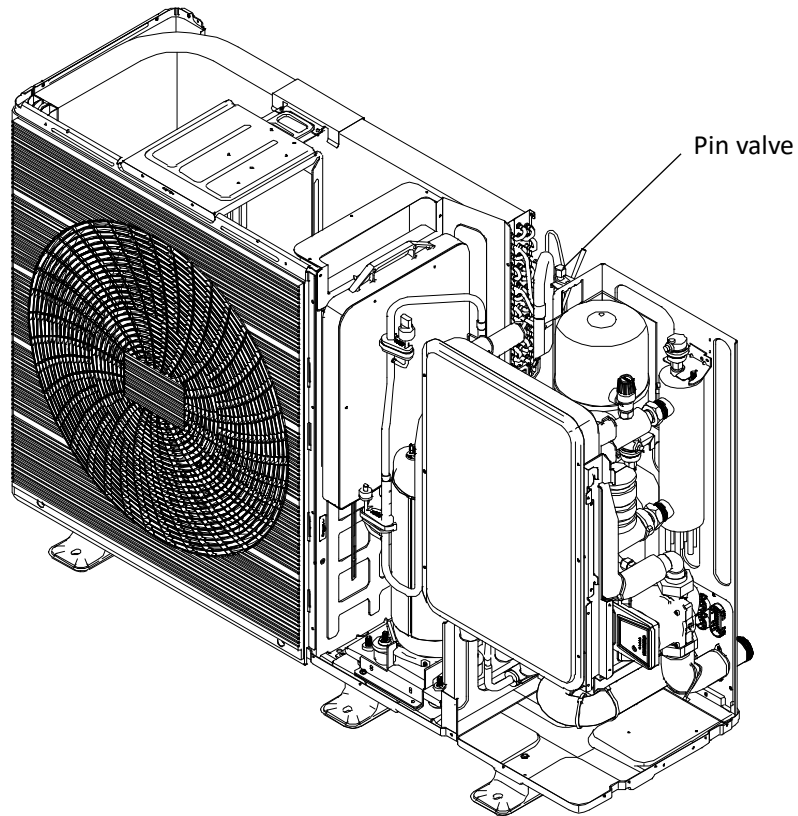

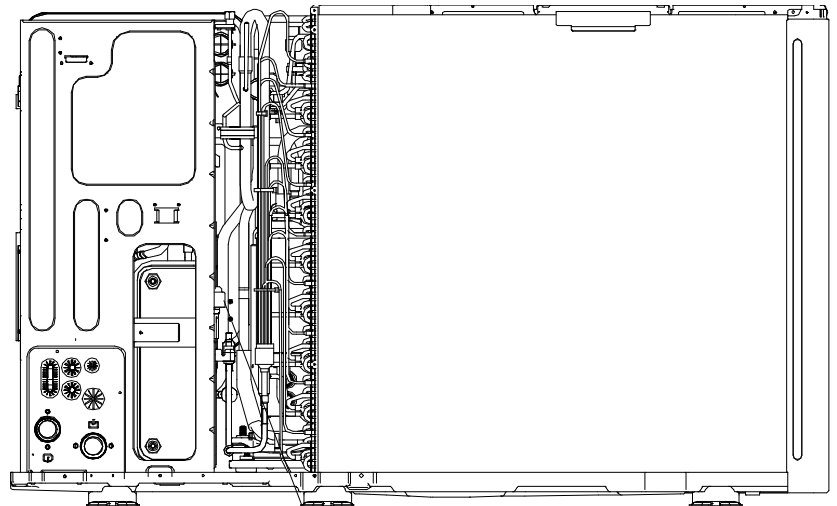
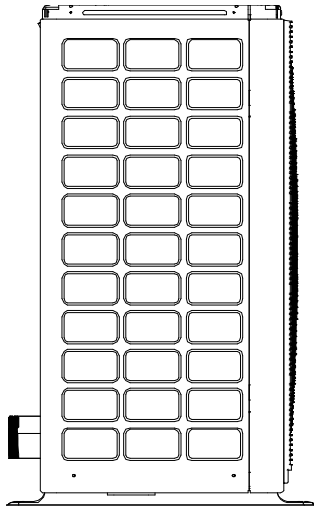

Electronic expansion valve

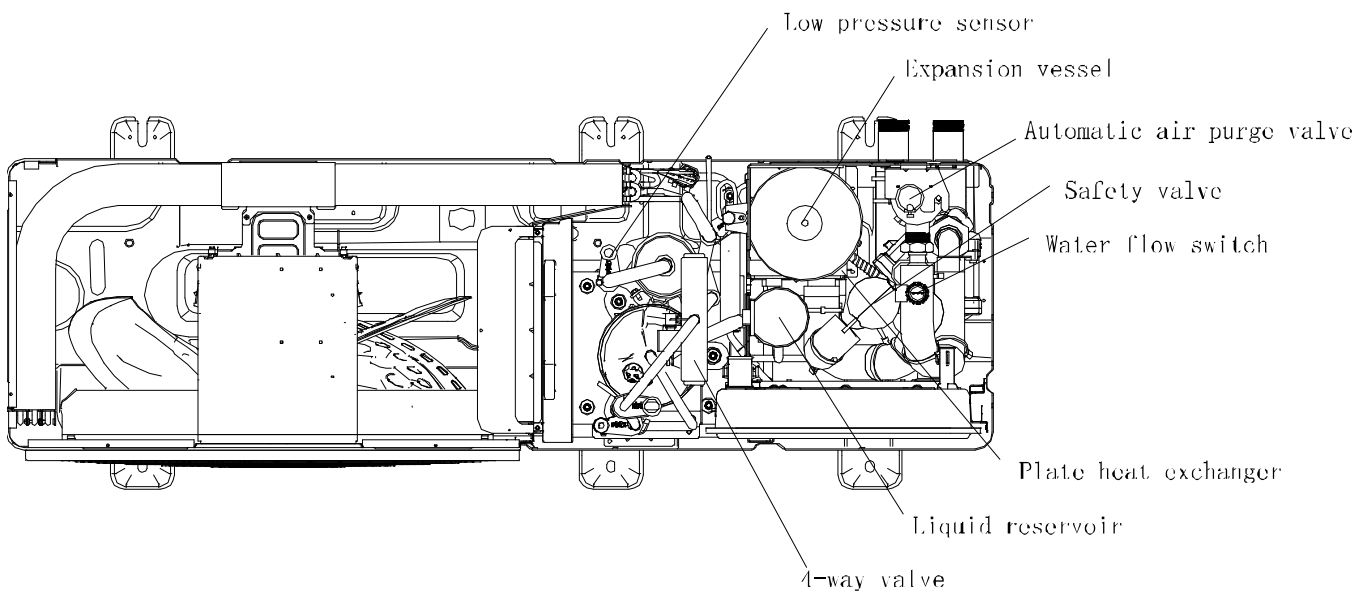

2 Piping Diagrams

Refrigerant piping graphic example:

- High temperature, high pressure gas
- High temperature, high pressure liquid
- Low temperature, low pressure gas liquid mixture
- Low temperature, low pressure gas

Note: The refrigerant flow direction shown in the figure is the main refrigerant flow direction for reference only.

2.1 heating mode

4-6kW

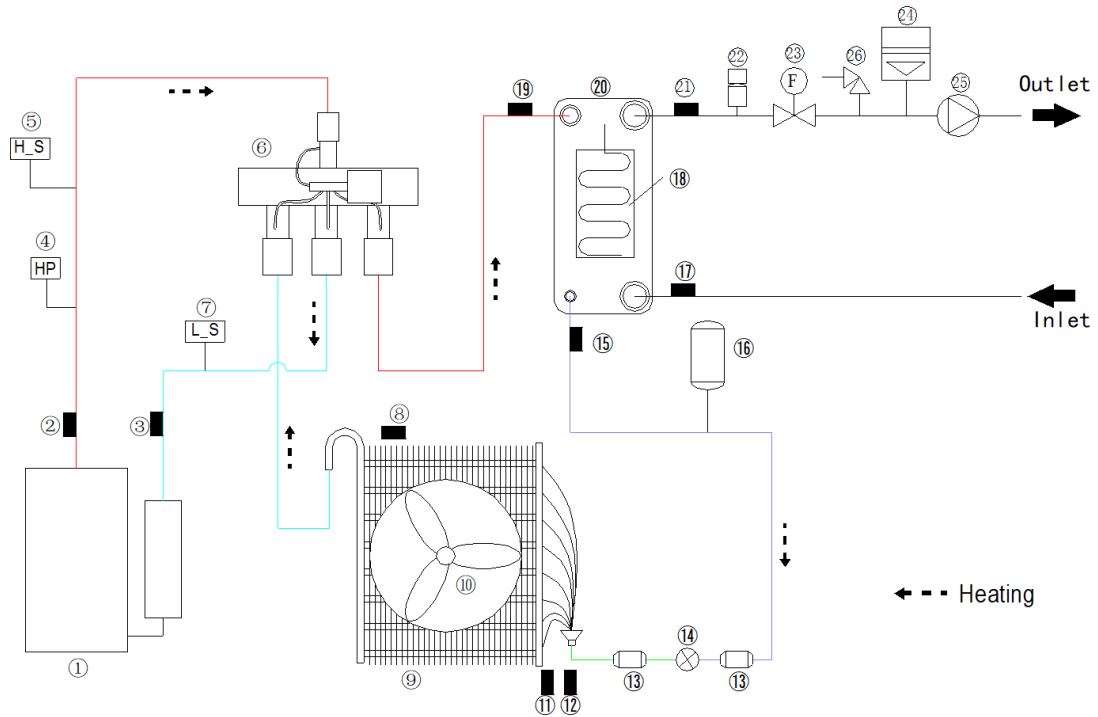

8-16kW

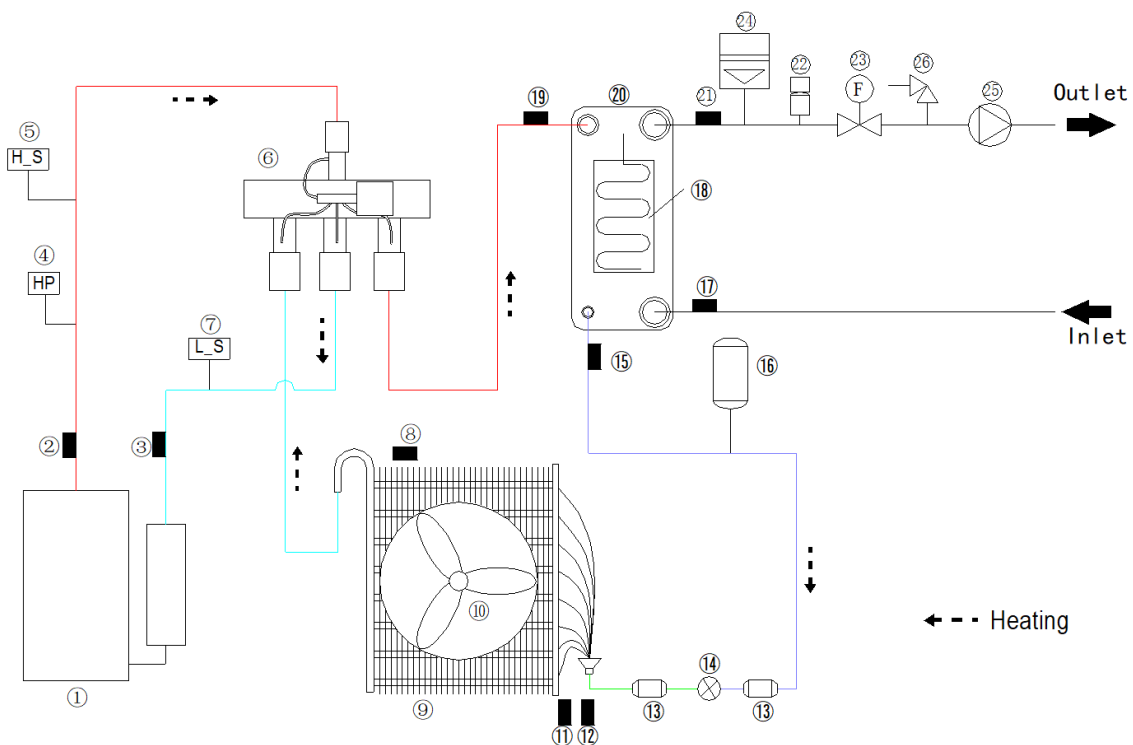

2.2 Cooling mode

4-6kW

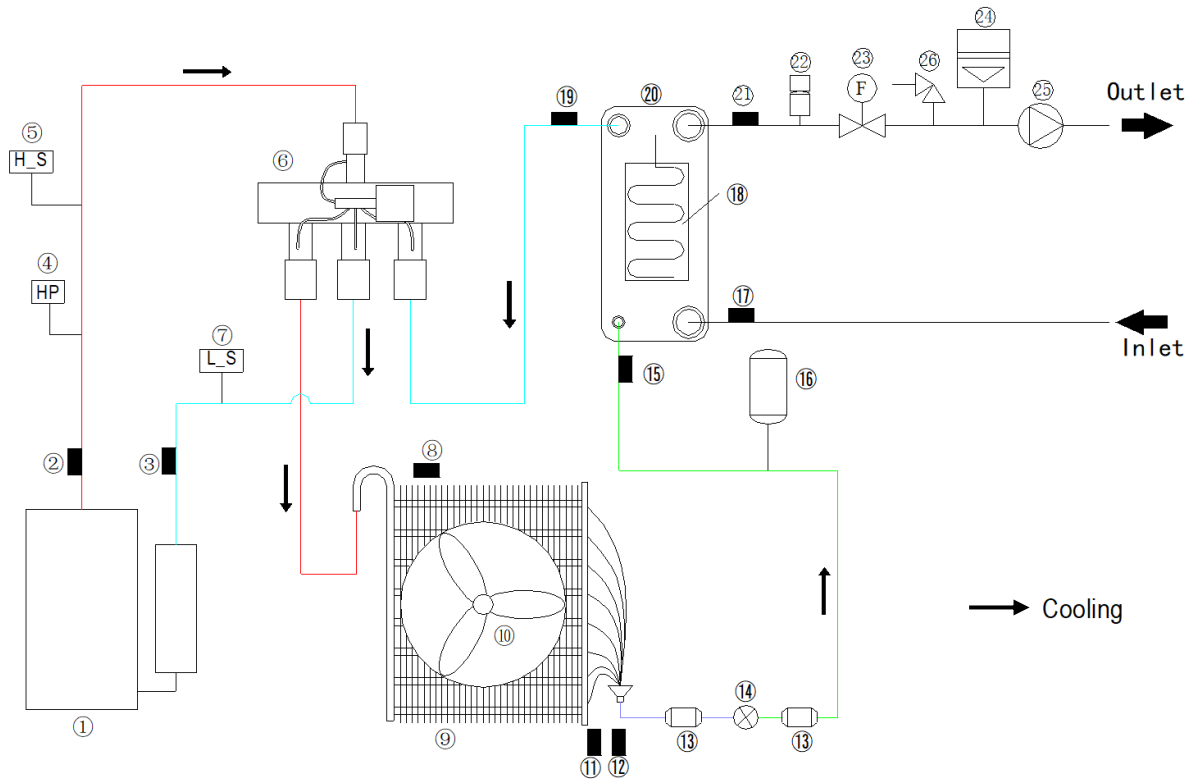

8-16kW

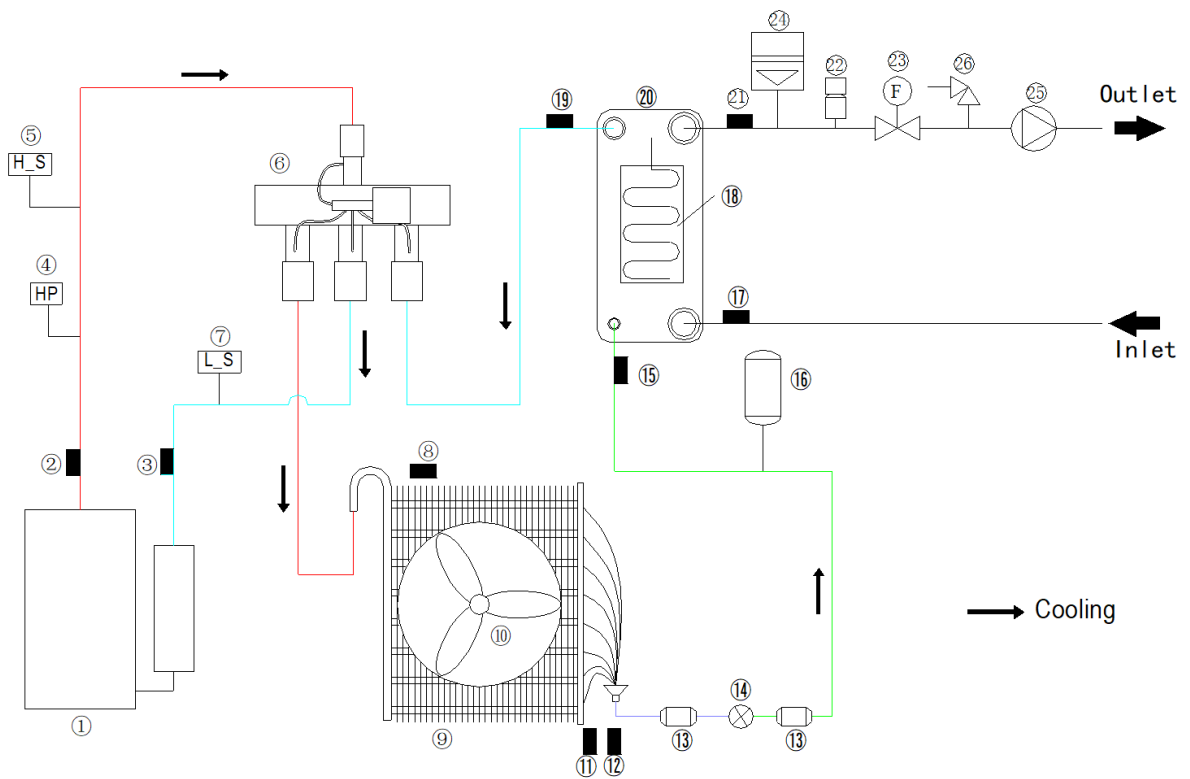

2.3 Key components

1	Compressor
2	Temperature sensor (Compressor discharge)
3	Temperature sensor (Compressor suction)
4	High pressure switch
5	High pressure sensor
6	4-way valve
7	Low pressure sensor
8	Temperature sensor (Outdoor air)
9	Finned tube Heat exchanger
10	Fan
11	Temperature sensor (Heat exchanger)
12	Temperature sensor (Heat exchanger outlet refrigerant)
13	Filter
14	Electronic expansion valve
15	Temperature sensor (Plate heat exchanger inlet refrigerant)
16	Liquid reservoir
17	Temperature sensor (Inlet water)
18	Heating tape of Plate heat exchanger
19	Temperature sensor (Plate heat exchanger outlet refrigerant)
20	Plate heat exchanger
21	Temperature sensor (Outlet water)
22	Automatic air purge valve
23	Water flow switch
24	Expansion vessel
25	Water pump
26	Pressure relief valve

- **Compressor:**

The refrigerant is compressed to very high pressures in the compressor, while its temperature is also raised. When the refrigerant enters a compressor, it is in a gaseous state at low pressure and low temperature and exits the compressor at high pressure and high temperature in a gaseous state.

- **4-way valve:**

To Control refrigerant flow direction. R290 M thermal Mono has upgraded the default position of 4-way valve, and made it to keep closed in heating mode and keep open in cooling mode. When closed, the air side heat exchanger functions as an evaporator and water side heat exchanger functions as a condenser; when open, the air side heat exchanger functions as a condenser and water side heat exchanger function as an evaporator.

- **High pressure switch:**

To regulate refrigerant system pressure. When refrigerant system pressure rises above the upper limit, the high pressure switch turns off, stopping the compressor.

- **Air side heat exchanger(Finned tube heat exchanger):**

To transfer heat between refrigerant and air. Refrigerant passes through the tube coils, conducts heat to the fins and dissipates heat to air forced through the heat exchanger.

- **Filter:**

To protect the inside of the heat pump from the dust and other contaminants that are found in the air, including hairs, pet dander and fibres. As the air passes through the filter, this dust and dirt gets caught to stop it from entering different parts of the system.

- **Electronic expansion valve (EXV):**

To Control refrigerant flow and reduces refrigerant pressure.

- **Liquid resevoir:**

To hold excess fluid refrigerant when the system is in operation.

- **Plate heat exchanger:**

To transfer heat between two fluids. This has a major advantage over a conventional heat exchanger in that the fluids are exposed to a much larger surface area because the fluids are spread out over the plates. This facilitates the transfer of heat, and greatly increases the speed of the temperature change.

- **Water pump (Circulating pump):**

To Circulate water in the water circuit.

- **Pressure relief valve:**

To control or limit the pressure in a system; excessive pressure might otherwise build up and create a process upset, instrument or equipment failure, explosion, or fire.

- **Internal backup heater(Optional):**

To Provide additional heating capacity when the heating capacity of the heat pump is insufficient due to very low outdoor temperature. Also protects the external water piping from freezing.

- **Automatic air purge valve:**

To automatically remove air from the water circuit.

- **Water flow switch:**

To detect water flow rate to protect compressor and water pump in the event of insufficient water flow.

- **Expansion vessel:**

To balance water system pressure. (Expansion vessel Nominal volume 8L, Actual volume 5L)

Part 3

Control and Field settings

1 Stop Operation	20
2 Standby Control.....	20
3 Startup Control.....	21
4 Normal Operation Control	24
5 Protection Control.....	26
6 Special Control.....	31
7 User Interface Field Settings	32
8 USB Function Field Settings	59

Notice

- The whole system diagram is illustrated as below for the understanding of the locations of key components and sensors.
- This is for reference only, it may vary from different scenarios and depend on the actual installation.

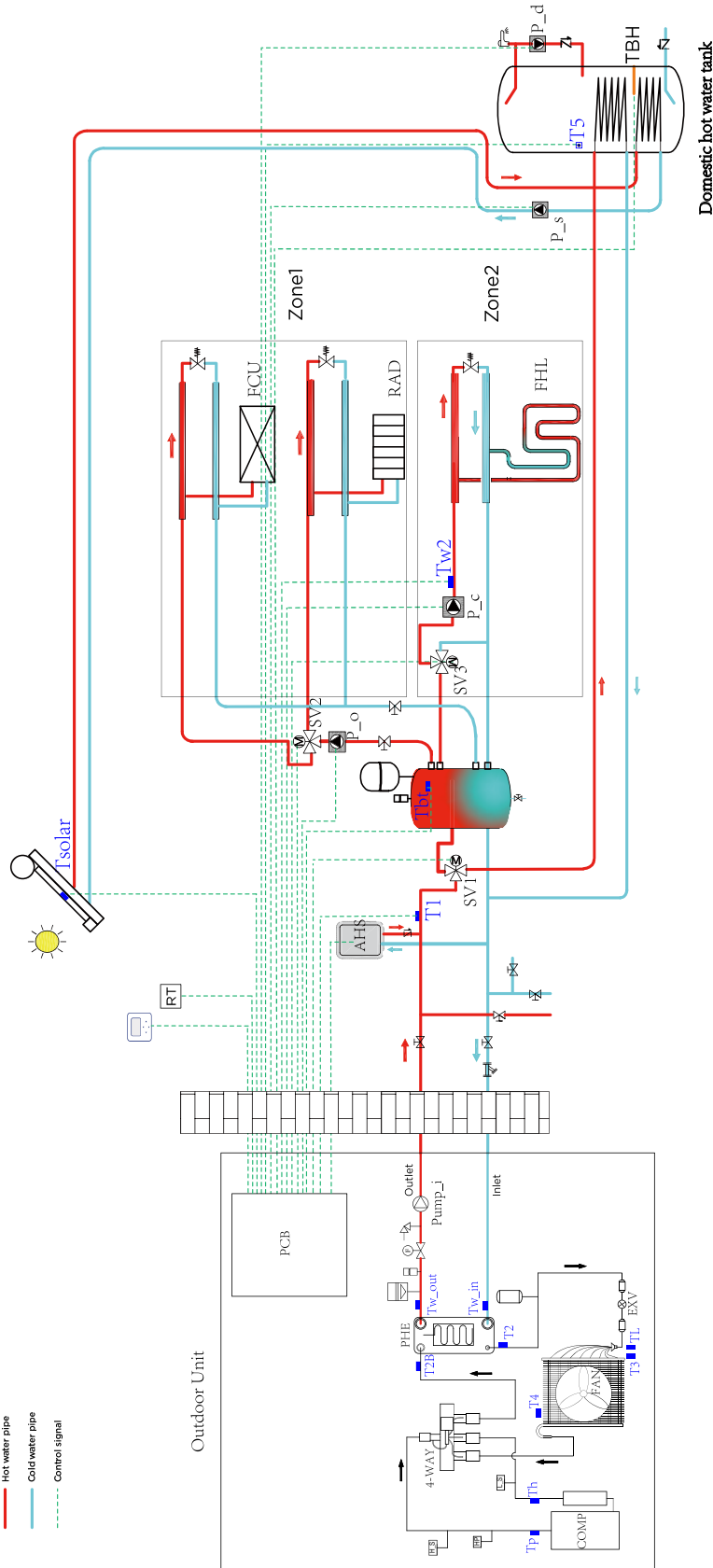

This diagram illustrates the system application only for reference

1 Stop Operation

The stop operation occurs for one of the following reasons:

1. Abnormal shutdown: in order to protect the compressors, if an abnormal state occurs the system makes a stop with thermo off operation and an error code is displayed on the outdoor unit PCB digital displays and on the user interface.
2. The system stops when the set temperature has been reached.

2 Standby Control

2.1 Crankcase Heater Control

The crankcase heater is used to prevent refrigerant from mixing with compressor oil when the compressors are stopped. The crankcase heater is controlled according to outdoor ambient temperature and the compressor on/off state. When the outdoor ambient temperature is above 8°C or the compressor is running, the crankcase heater is off; when the outdoor ambient temperature is at or below 8°C and either the compressor has been stopped for more than 3 hours or the unit has just been powered-on (either manually or when the power has returned following a power outage), the crankcase heater turns on.

2.2 Water Pump Control

When the outdoor unit is in standby, the internal and external circulator pumps run continuously.

3 Startup Control

3.1 Compressor Startup Delay Control

In initial startup control and in restart control (except in oil return operation and defrosting operation), compressor startup is delayed such that a minimum of the set re-start delay time 3minutes has elapsed since the compressor stopped, in order to prevent frequent compressor on/off and to equalize the pressure within the refrigerant system.

3.2 Compressor Startup Program

In initial startup control and in re-start control, compressor startup is controlled according to outdoor ambient temperature. Compressor startup follows one of two startup programs until the target rotation speed is reached.

4-10kw compressor startup program when cooling mode ambient temperature is above 12°C & when heating mode ambient temperature is above 0°C

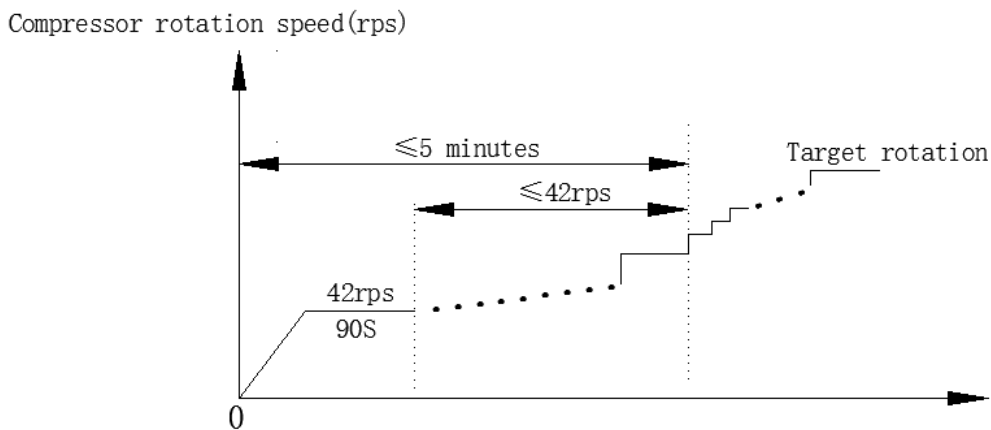

4-10kw compressor startup program when cooling mode ambient temperature is below 12°C & when heating mode ambient temperature is below 0°C

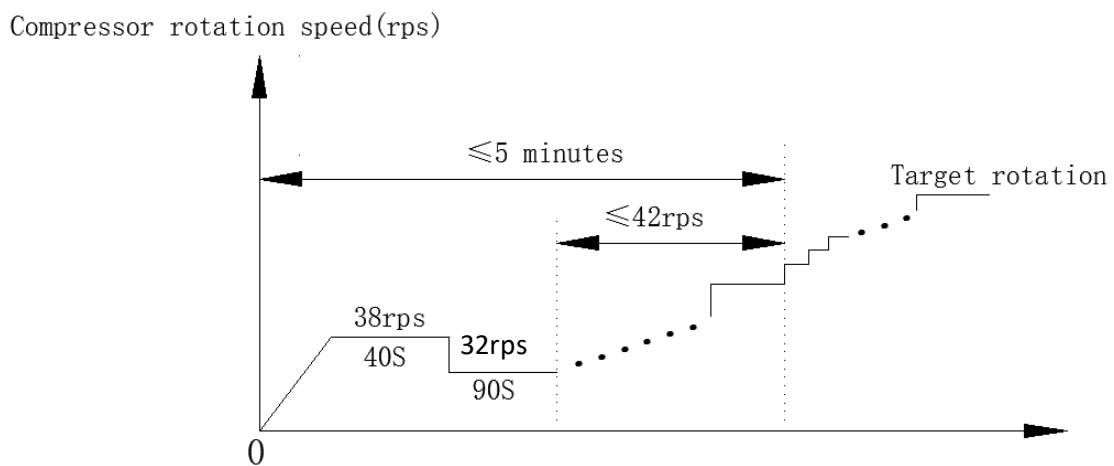

12-16kw compressor startup program when cooling mode ambient temperature is above 12°C & when heating mode ambient temperature is above 0°C

Compressor rotation speed(rps)

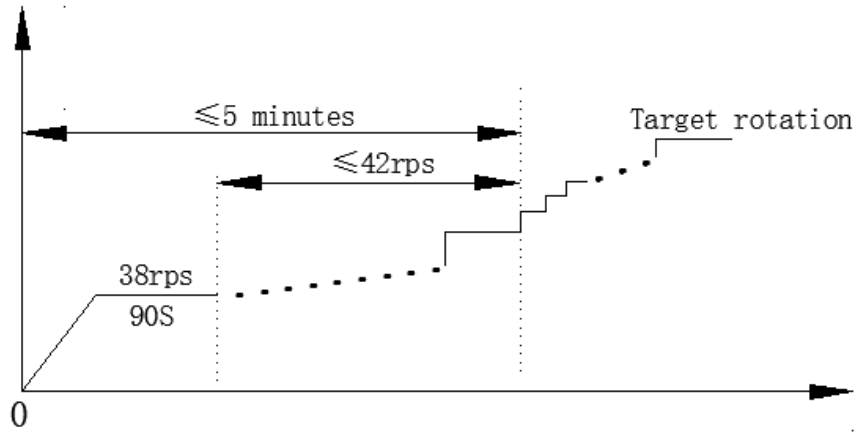

12-16kw compressor startup program when cooling mode ambient temperature is below 12°C & when heating mode ambient temperature is below 0°C

Compressor rotation speed(rps)

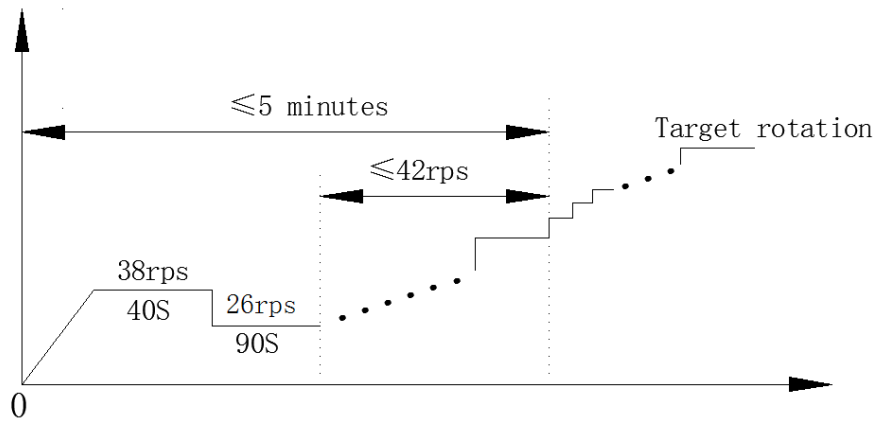

3.3 Startup Control for Heating and Domestic Hot Water Operation

Component control during startup in heating and domestic hot water modes

Component	Wiring diagram label	4-16kW	Control functions and states
Inverter compressor	COMP	•	Compressor startup program selected according to ambient temperature ¹
DC fan motor	FAN	•	Fan run at maximum speed ²
Electronic expansion valve	EXV	•	Position (steps) from 0 (fully closed) to 480 (fully open), controlled according to outdoor ambient temperature, discharge temperature, suction superheat, compressor speed and refrigerant system pressure
Four-way valve	4-WAY	•	OFF
Notes:			
1. Refer to "Startup Control - Compressor Startup Program".			
2. Refer to "Nomal Operation Control - Outdoor Fan Control"			

3.4 Startup Control for Cooling Operation

Component control during startup in cooling mode

Component	Wiring diagram label	4-16kW	Control functions and states
Inverter compressor	COMP	•	Compressor startup program selected according to ambient temperature ¹
DC fan motor	FAN	•	Fan run at maximum speed ²
Electronic expansion valve	EXV	•	Position (steps) from 0 (fully closed) to 480 (fully open), controlled according to outdoor ambient temperature, discharge temperature, suction superheat, compressor speed and refrigerant system pressure
Four-way valve	4-WAY	•	ON
Notes:			
1. Refer to "Startup Control - Compressor Startup Program".			
2. Refer to "Nomal Operation Control - Outdoor Fan Control"			

4 Normal Operation Control

4.1 Component Control during Normal Operation

Component control during heating and domestic hot water operations

Component	Wiring diagram label	4-16kW	Control functions and states
Inverter compressor	COMP	•	Controlled according to load requirement from temperature set and outlet water temperature
DC fan motor	FAN	•	Controlled according to outdoor heat exchanger pipe temperature
Electronic expansion valve	EXV	•	Position (steps) from 0 (fully closed) to 480 (fully open), controlled according to outdoor ambient temperature, discharge temperature, suction superheat, compressor speed, refrigerant system pressure and temperature
Four-way valve	4-WAY	•	OFF

Component control during cooling operation

Component	Wiring diagram label	4-16kW	Control functions and states
Inverter compressor	COMP	•	Controlled according to load requirement from set temperature and outlet water temperature
DC fan motor	FAN	•	Controlled according to outdoor heat exchanger pipe temperature
Electronic expansion valve	EXV	•	Position (steps) from 0 (fully closed) to 480 (fully open), controlled according to outdoor ambient temperature, discharge temperature, suction superheat, compressor speed and refrigerant system pressure
Four-way valve	4-WAY	•	ON

4.2 Compressor Output Control

The compressor rotation speed is controlled according to the load requirement. Before compressor startup, the outdoor unit determines the compressor target speed according to outdoor ambient temperature, leaving water set temperature and actual leaving water temperature and then runs the appropriate compressor startup program. Refer to Part 3.2 "Compressor Startup Program". Once the startup program is complete, the compressor runs at the target rotation speed. During operation the compressor speed is controlled according to the rate of change in water temperature, the refrigerant system pressure and the refrigerant temperature.

4.3 Compressor Frequency Control

The running speed of six-pole compressors in rotations per second (rps) is one third of the frequency (in Hz) of the electrical input to the compressor motor. The frequency of the electrical input to the compressor motors can be altered at a rate of 1Hz per second.

4.4 Four-way Valve Control

The four-way valve is used to change the direction of refrigerant flow through the water side heat exchanger in order to switch between cooling and heating/DHW operations.

During heating and DHW operations, the four-way valve is off; during cooling and defrosting operations, the four-way valve is on.

4.5 Electronic Expansion Valve Control

The position of the electronic expansion valve (EXV) is controlled in steps from 0 (fully closed) to 480 (fully open).

- At power-on:
 - The EXV first closes fully, then moves to the standby position (480 (steps)). After compressor runs the EXV is controlled according to suction superheat discharge temperature, pressure, discharge temperature and compressor speed.
- When the outdoor unit is in standby:
 - The EXV is at position 480 (steps).
- When the outdoor unit stops:
 - The EXV first moves to 480 (steps) and remains for 30 seconds, then closes fully, then moves to the standby position (480 (steps)).

4.6 Outdoor Fan Control

The speed of the outdoor unit fan is adjusted in steps, as shown below.

Fan speed control during operation

Fan speed index	Fan speed (rpm)						
	4kW	6kW	8kW	10kW	12kW	14kW	16kW
W1	200	200	200	200	200	200	200
W2	250	250	250	250	250	250	250
W3	300	300	300	300	300	300	300
W4	350	350	350	350	350	350	350
W5	400	400	400	400	400	400	400
W6	450	450	450	450	450	450	450
W7	500	500	520	520	500	500	500
W8	530	530	530	530	550	550	550
W9	550	550	550	550	580	580	600
W10	580	580	580	580	610	610	650
W11	600	600	600	600	650	650	700
W12	600	600	600	600	680	680	750
W13	600	600	600	600	700	700	780

5 Protection Control

5.1 High Pressure Protection Control

This control protects the refrigerant system from abnormally high pressure and protects the compressor from transient spikes in pressure.

High pressure protection control

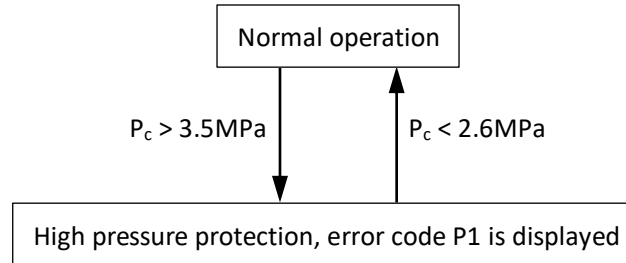

Notes:

1. P_c : Discharge pressure

When the discharge pressure rises above 3.5MPa the system displays P1 protection and the unit stops running. When the discharge pressure drops below 2.6MPa, the compressor enters re-start control.

5.2 Low Pressure Protection Control

This control protects the refrigerant system from abnormally low pressure and protects the compressor from transient drops in pressure.

Low pressure protection control

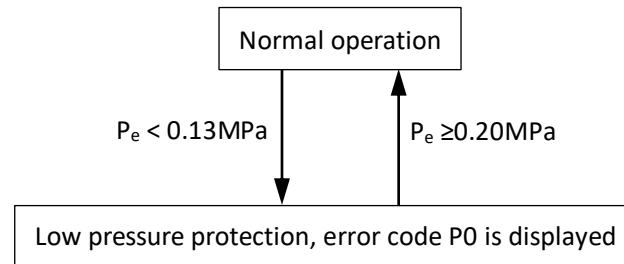

Notes:

1. P_e : Suction pressure

When the suction pressure drops below 0.13MPa the system displays P0 protection and the unit stops running. When the suction pressure rises above 0.2MPa, the compressor enters re-start control.

5.3 Discharge Temperature Protection Control

This control protects the compressor from abnormally high temperatures and transient spikes in temperature.

High discharge temperature protection control

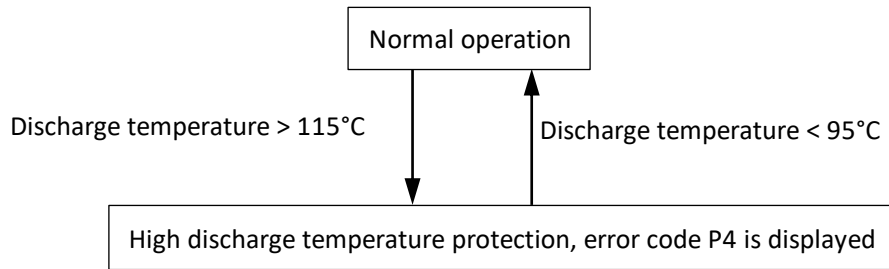

When the discharge temperature rises above 115°C the system displays P4 protection and the unit stops running. When the discharge temperature drops below 95°C, the compressor enters re-start control.

Low discharge temperature protection control

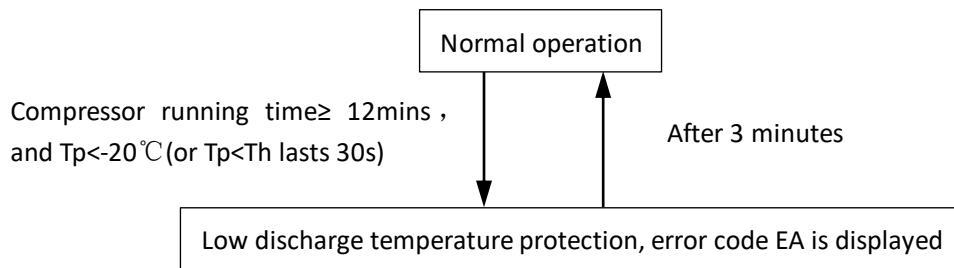

When the discharge temperature(Tp) is below sunction temperature(Th) for more than 12 minutes after compressor operates, the system displays EA protection and the unit stops running. After 3 mintues the compressor enters re-start control.

Note: EA protection occurs 3 times within 2 hours, the outdoor unit cannot be restarted unless it is powered on again.

5.4 Compressor Current Protection Control

This control protects the compressor from abnormally high currents.

Figure 3-5.5: Compressor current protection control

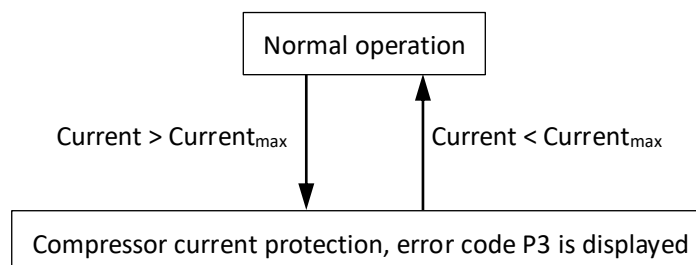

Current limitation for ODU

Model	1-ph 4-6kw	1-ph 8-10kw	1-ph 12-16kw	3-ph 12-16kw
Current _{max}	15A	19A	31A	11A

When the compressor current rises above Current_{max} the system displays P3 protection and the unit stops running. When the compressor current drops below Current_{max}, the compressor enters re-start control.

5.5 Voltage Protection Control

This control protects the M-Thermal Split from abnormally high or abnormally low voltages.

Figure 3-5.6: Compressor voltage protection control

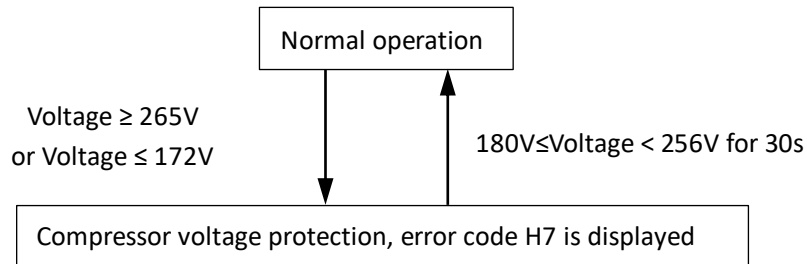

When the phase voltage of AC power supply is at or above 265V, the system displays H7 protection and the unit stops running. When the phase voltage drops below 265V for more than 30 seconds, the refrigerant system restarts once the compressor re-start delay has elapsed. When the phase voltage is below 172V, the system displays H7 protection and the unit stops running. When the AC voltage rises to more than 180V, the refrigerant system restarts once the compressor re-start delay has elapsed.

5.6 DC Fan Motor Protection Control

This control protects the DC fan motors from strong winds and abnormal power supply. DC fan motor protection occurs when any one of the following conditions are met:

- Fan speed continues to be less than 50rpm more than 40S from the set fan step > 0
- Fan speed is lower than 50rpm for 3S, during normal operation

When DC fan motor protection control occurs the system displays the H6 error code and the unit stops running. After 30S, the unit restarts automatically. When H6 protection occurs 10 times in 120 minutes, the HH error is displayed. When an HH error occurs, a manual system restart is required before the system can resume operation.

5.7 Anti-freezing Protection Control

This control protects the water side heat exchanger from ice formation. The water side heat exchanger electric heater is controlled according to outdoor ambient temperature, water side heat exchanger water inlet temperature and water side heat exchanger water outlet temperature.

In cooling mode, if inlet water temperature or leaving water temperature or auxiliary heat source leaving water temperature is below 4°C, the anti-freeze protection actions. In heating/DHW mode, if ambient temperature is below 3°C and inlet water temperature or leaving water temperature or auxiliary heat source leaving water temperature is below 4°C, the anti-freeze protection actions. In heating/DHW mode, leaving water temperature is below 2°C, the anti-freeze protection actions.

When water side heat exchanger anti-freeze protection occurs the system displays error code Pb and the unit stops running.

Note: For the clear and concise understanding of anti-freeze protection control, the diagram is illustrated as below.

Anti-freezing control in Cooling mode

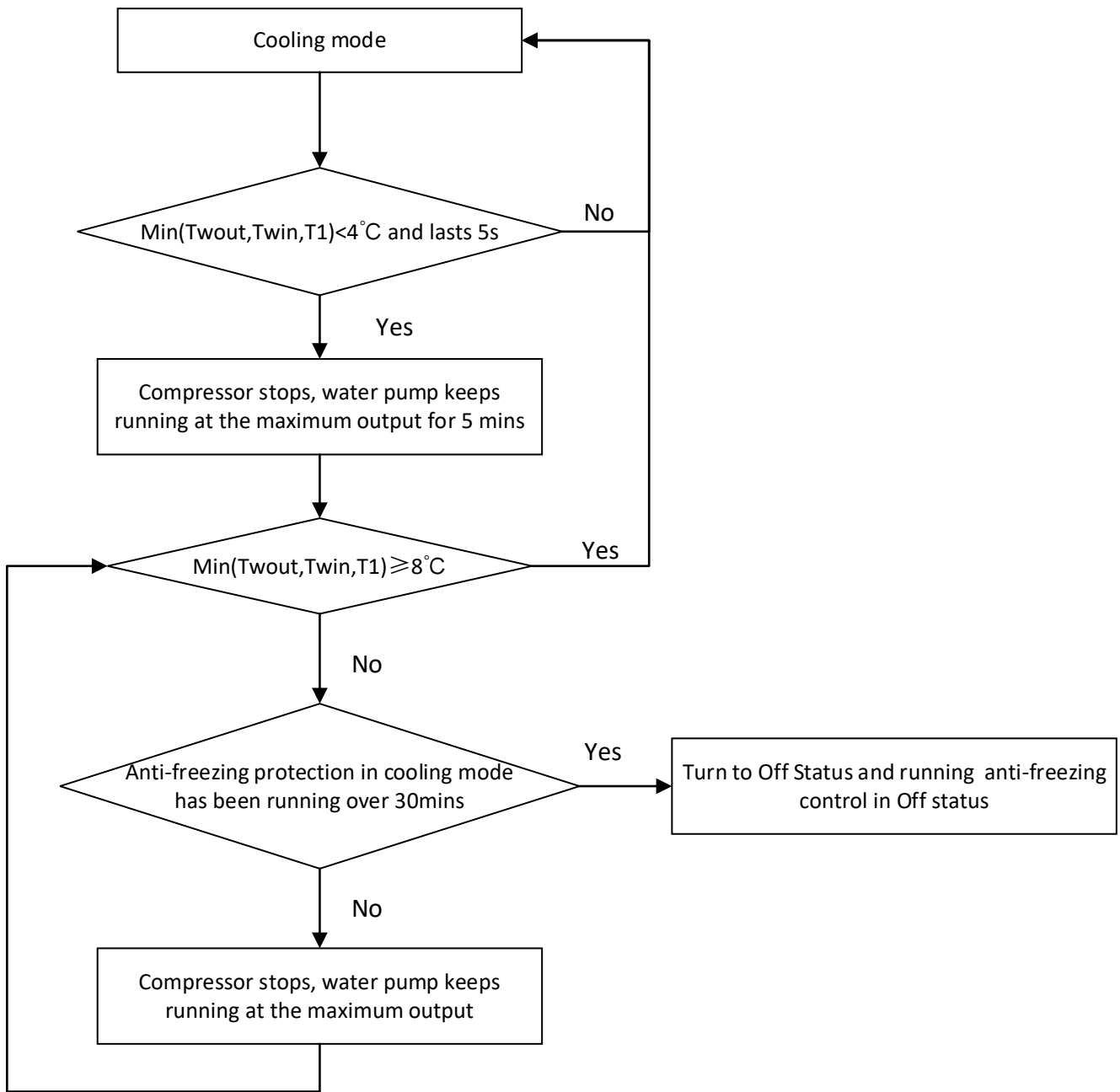

Tw_out: Plate heat exchanger outlet water temperature

Tw_in: Plate heat exchanger inlet water temperature

T1: Electric Heater/AHS water outlet temperature

Anti-freezing control in Off status/ Heating mode/ DHW mode

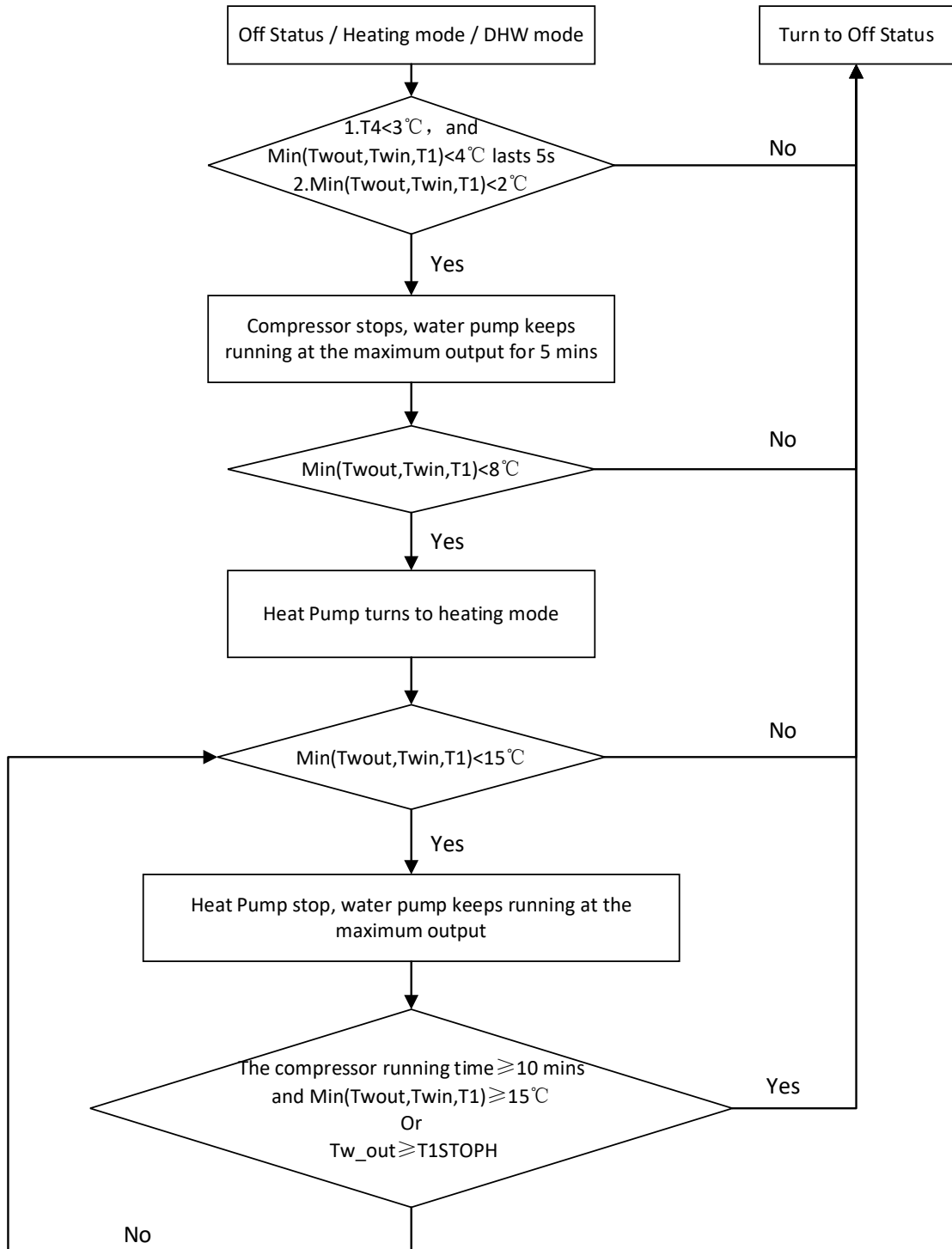

T4: Ambient temperature

Tw_out: Plate heat exchanger outlet water temperature

Tw_in: Plate heat exchanger inlet water temperature

T1: Electric Heater/AHS water outlet temperature

T1STOPH: The maximum temperature to stop compressor in heating mode

6 Special Control

6.1 Oil Return Operation

In order to prevent the compressor from running out of oil, the oil return operation is conducted to recover oil that has flowed out of the compressor and into the refrigerant piping. When the oil return operation is being conducted, the outdoor unit refrigerant system main PCB displays code d0.

The oil return operation starts when the following condition occurs:

- When the compressor cumulative operating time with running rotation speed less than 42rps reaches 6 hours.

The oil return operation ceases when any one of the following two conditions occurs:

- Oil return operation duration reaches 5 minutes.
- Compressor stops.

Component control during oil return operation in **cooling mode**.

Component	Wiring diagram label	4-16kW	Control functions and states
Inverter compressor	COMP	●	Runs at oil return operation rotation speed
DC fan motor	FAN	●	Controlled according to cooling mode
Electronic expansion valve	EXV	●	304 (steps)
Four-way valve	4-WAY	●	ON

Component control during oil return operation in **heating and DHW** modes.

Component	Wiring diagram label	4-16kW	Control functions and states
Inverter compressor	COMP	●	Runs at oil return operation rotation speed
DC fan motor	FAN	●	Controlled according to heating mode
Electronic expansion valve	EXV	●	304 (steps)
Four-way valve	4-WAY	●	OFF

6.2 Defrosting Operation

In order to recover heating capacity, the defrosting operation is conducted when the outdoor unit air side heat exchanger is performing as a condenser. The defrosting operation is controlled according to outdoor ambient temperature, air side heat exchanger refrigerant outlet temperature and the compressor running time.

Component control during defrosting operation

Component	Wiring diagram label	4-16kW	Control functions and states
Inverter compressor	COMP	●	Runs at defrosting operation rotation speed
DC fan motor	FAN	●	Off
Electronic expansion valve	EXV	●	Fully open
Four-way valve	4-WAY	●	ON

7 User Interface Field Settings

7.1 Introduction

During installation, the parameters setting should be configured by the installer to suit the installation configuration, climate conditions and end-user preferences. The relevant settings are accessible and programmable through the FOR **SERVICEMAN** menu on the user interface. The user interface menus and settings can be navigated using the touch-sensitive keys.

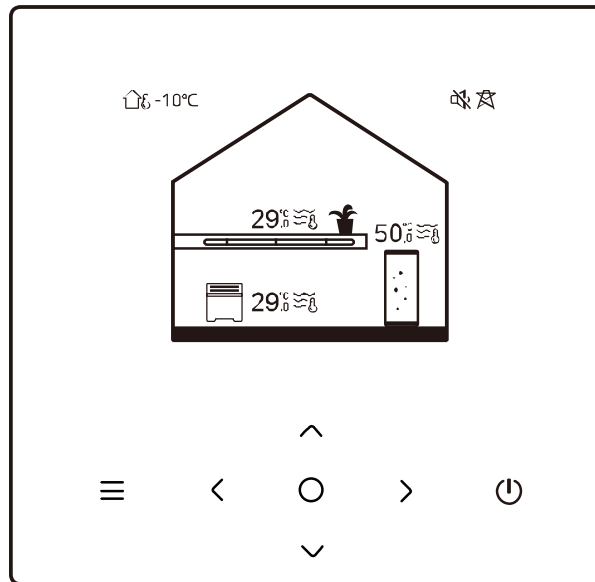

Icon	Name	Function
≡	Menu	Press to access the menu page (from the home page) Return to the previous page(from a page other then the home page)
	Return	Hold for 2 seconds to return to the main page.
○	Confirm	Confirm a selection Save settings Access the next page
⏻	ON/OFF	Turn on/off zone 1/zone 2/DHW Press and hold for 3 seconds to turn on/off zone 1 / zone 2 / DHW
< ^ > v	Navigation	Press to navigate the cursor to adjust settings (holding it for 1 second can start quick adjustment)

Combinations of buttons:

Press ≡ and > simultaneously for 3 seconds to enter the **For serviceman** menu.

7.2 Menu Structure

For serviceman

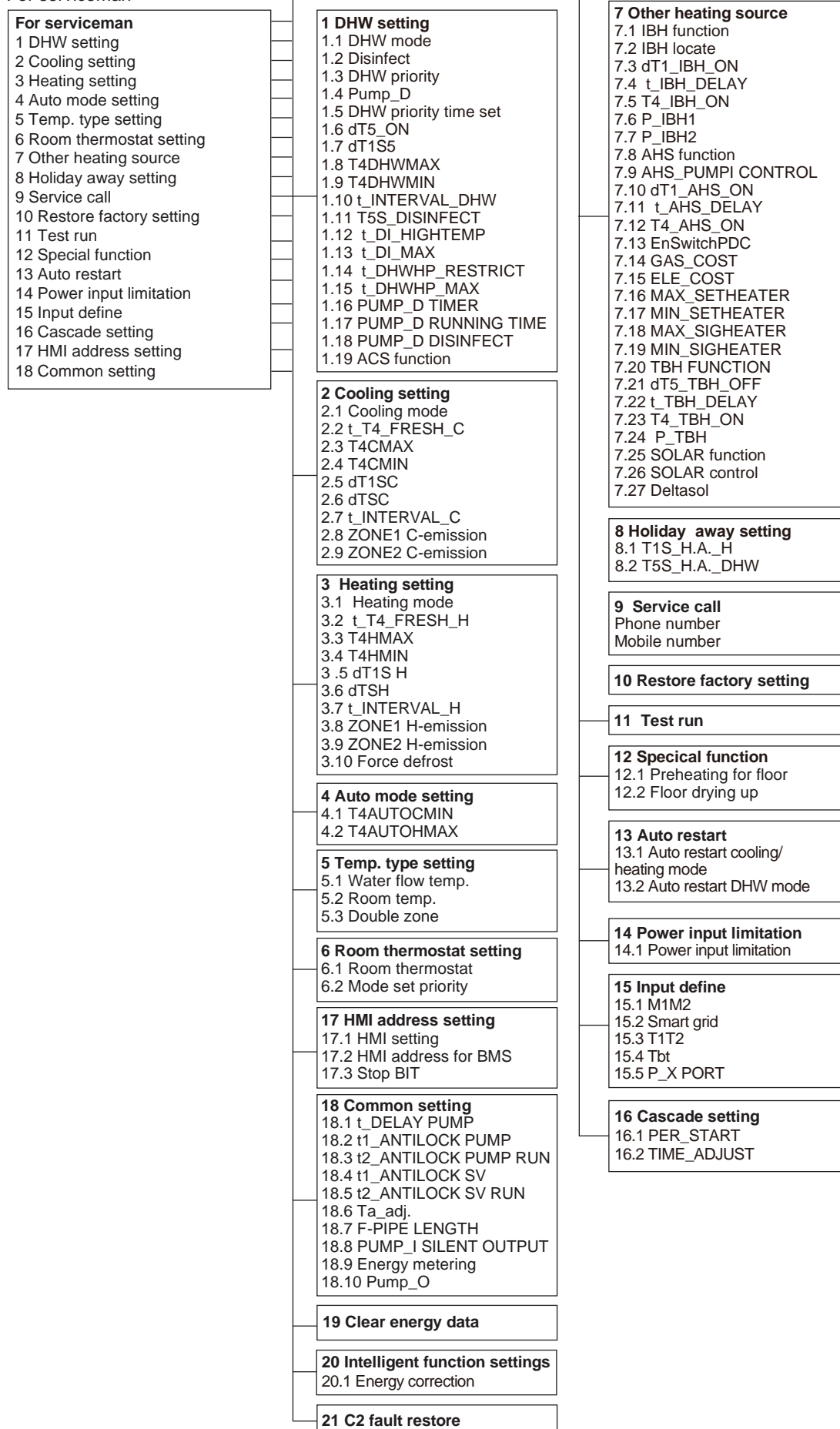

There are some items that are invisible if the function is disabled or unavailable.

7.3 FOR SERVICEMAN Menu

For serviceman allows installers to input the system configuration and set the system parameters.

Press \equiv and $\>$ simultaneously for 3 seconds to enter the authorization page.

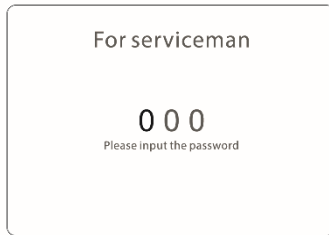

Press $\langle \rangle$ to navigate cursor and press \diamond to adjust the numerical values. The password is 234. Press \circ to enter **For serviceman** menu.

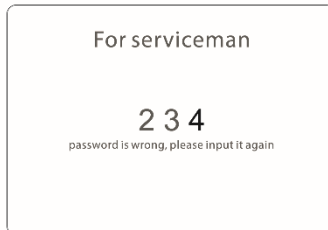

Then the following pages will be displayed:

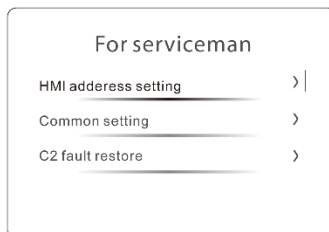
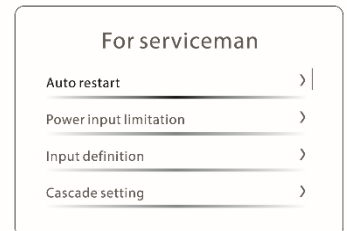
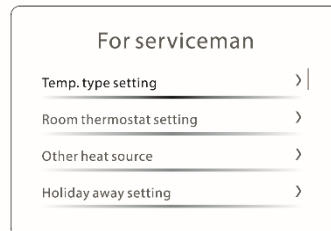
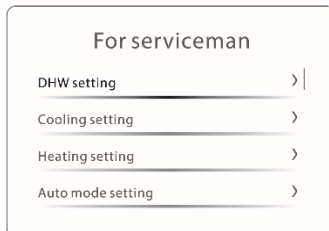

7.3.1 DHW heating setting

DHW setting	
DHW mode	1
Disinfect	0
HDW priority	1
Pump_D	1

DHW setting	
DHW priority time set	1
dT5_ON	10°C
dT155	10°C
T4DHWMAX	45°C

DHW setting	
T4DHWMIN	-10°C
t_INTERVAL_DHW	5minutes
T55_DISINFECT	65°C
t_DI_HIGHTEMP.	15minutes

DHW setting	
t_DI_MAX	210minutes
t_IDHWHP_RESTRICT	30minutes
t_DHWHP_MAX	90minutes
PUMP_DTIMER	1

DHW setting	
PUMP_DRUNNINGTIME	5minutes
PUMP_DDISINFECT	1
ACSfunction	0

7.3.1.1 DHW mode

DHW mode defines whether hot water demand is needed.

Setting	Description
1	Enable DHW mode if DHW tank is installed.
0	Disable DHW mode if DHW tank is not installed. In this case, no need to define other settings in DHW setting .

7.3.1.2 Disinfect, T55_DISINFECT, t_DI_HIGHTEMP, t_DI_MAX

Disinfect defines whether disinfection function is activated.

Setting	Description
1	Enable DHW tank disinfection function.
0	Disable DHW tank disinfection function.

T55_DISINFECT defines the target water temperature of water tank for disinfection function.

t_DI_HIGHTEMP defines Period that disinfection water target temperature maintains.

t_DI_MAX defines duration of disinfection mode.

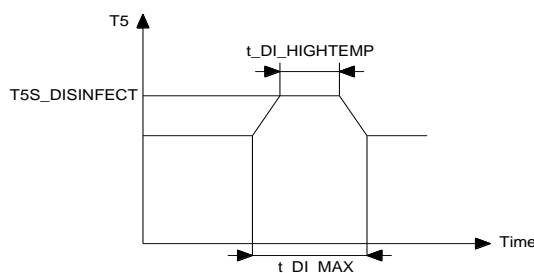

Abbreviations:

T5: DHW tank water temperature

7.3.1.3 DHW priority, DHW priority time set, t_DHWHP_RESTRICT, t_DHWHP_MAX

DHW priority defines whether domestic hot water or space heating/cooling takes priority.

Setting	Description
1	When DHW demand and space heating/cooling demand both exist, heat pump will heat the water according to the setting of DHW priority time set, t_DHWHP_RESTRICT, t_DHWHP_MAX
0	When DHW demand and space heating/cooling demand both exist, heat pump will heat the water after space heating/cooling demand is satisfied.

DHW priority time set defines whether **t_DHWHP_RESTRICT**(the operation time of heating/cooling mode) is to be considered before switching to DHW mode and whether **t_DHWHP_MAX**(the operation time of DHW mode) is to be considered before switching to heating/cooling mode.

Setting	Description
1	Enable the setting of t_DHWHP_RESTRICT, t_DHWHP_MAX
0	Disable the setting of t_DHWHP_RESTRICT, t_DHWHP_MAX

t_DHWHP_RESTRICT defines the period that heat pump runs in space heating/cooling mode before switching to DHW mode if DHW requirement exists.

t_DHWHP_MAX defines the period that heat pump runs in DHW mode before switching to space heating/cooling mode if space heating/cooling requirement exists.

Diagram below illustrates the effects of **t_DHWHP_MAX** and **t_DHWHP_RESTRICT** when **DHW PRIORITY** and **DHW priority time set** are enabled.

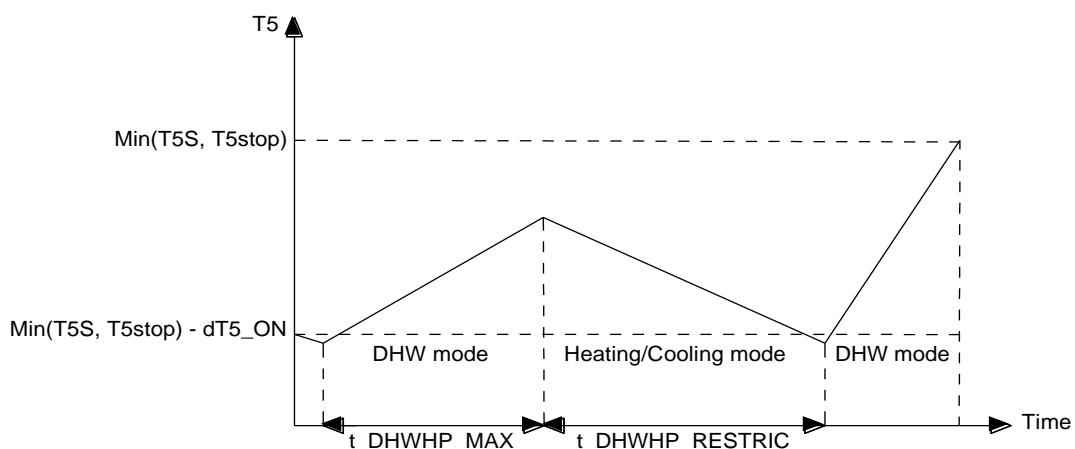

Abbreviations:

T5: DHW tank water temperature

T5S: DHW tank set temperature

T5stop: Leaving water temperature operating limit of DHW mode

DHW PRIORITY	DHW PRIORITY TIME SET	t_DHWHP_RESTRICT	t_DHWHP_MAX	Heating/Cooling turns to DHW	DHW turns to Heating/Cooling
1	1	A min	B min	&& DHW mode ON && $T5 < \text{MIN}(T5S, T5STOP) - dT5_ON$ && Heating/Cooling mode operates for A mins	DHW mode OFF $T5 \geq \text{MIN}(T5S, T5STOP)$ DHW mode operates for B mins && Heating/Cooling mode ON
1	0	-	-	&& DHW mode ON && $T5 < \text{MIN}(T5S, T5STOP) - dT5_ON$	DHW mode OFF $T5 \geq \text{MIN}(T5S, T5STOP)$ && Heating/Cooling mode ON
0	-	-	-	&& DHW mode ON && $T5 < \text{MIN}(T5S, T5STOP) - 1$ && Heating/Cooling mode OFF	Heating/Cooling mode ON

Diagram below illustrates the effects when **DHW priority time set** is disabled.

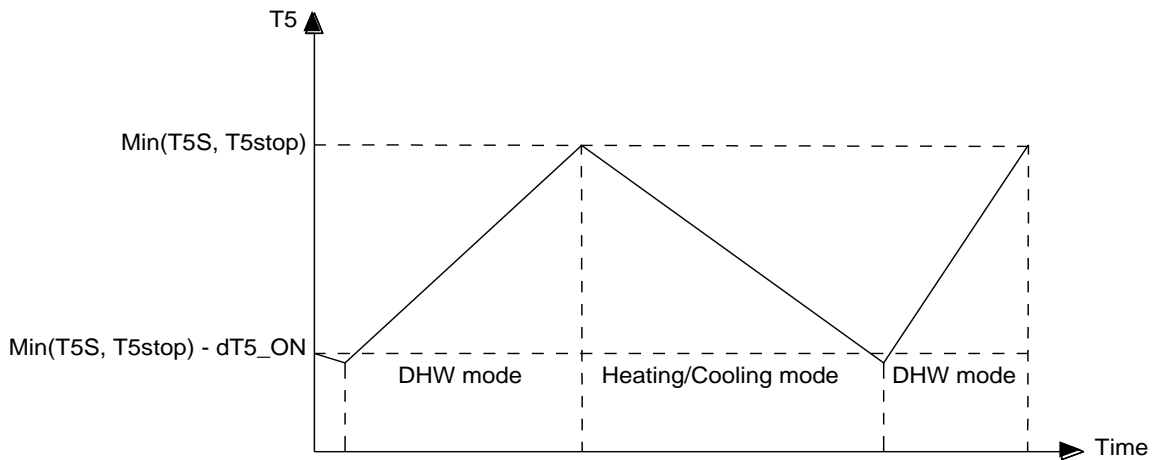

Abbreviations:

T5: DHW tank water temperature

T5S: DHW tank set temperature

T5stop: Leaving water temperature operating limit of DHW mode

7.3.1.4 Pump_D, PUMP_D TIMER, PUMP_D RUNNING TIME, PUMP_D DISINFECT

DHW pump(**Pump_D**) is installed to circulate the water in the DHW pipe network.

Setting	Description
1	Installation with DHW pump.
0	Installation without DHW pump.

PUMP_D TIMER defines whether DHW pump operation schedule which is defined in the user menu is activated.

Setting	Description
1	Enable DHW pump run in timer.
0	Disable DHW pump run in timer.

PUMP_D RUNNING TIME defines the period that DHW pump operates for each timer

Diagram below illustrates the effects of **PUMP_D RUNNING TIME** when **Pump_D** is installed and **PUMP_D TIMER** is enable.

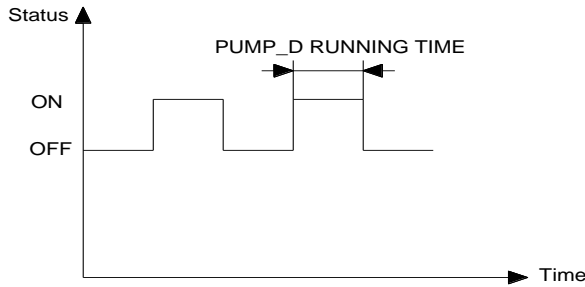

PUMP_D DISINFECT defines whether DHW pump operation is activated in disinfection mode.

Setting	Description
1	When heat pump is in disinfection mode and $T5S_DISINFECT - T5 \leq 2$, DHW pump operates PUMP_D RUNNING TIME+5 minutes T5S_DISINFECT: DHW tank disinfection set temperature T5S: DHW tank set temperature
0	Disable the DHW pump operates when heat pump is in disinfection mode

7.3.1.5 dt5_ON

dt5_ON defines water temperature hysteresis of activating heat pump.

When $T5S - T5 \geq dt5_ON$ and heat pump is within operating ambient temperature range, heat pump provides hot water to the DHW tank.

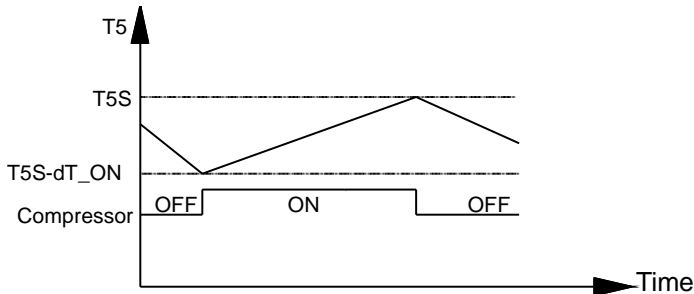

Abbreviations:

T5: DHW tank water temperature

T5S: DHW set temperature

7.3.1.6 dt1S5

Leaving water set temperature(T1S) for DHW mode is calculated by formula: $T1S = T5 + \Delta dt1S5 + dt1S5$

T1S: Leaving water set temperature

T5: DHW tank water temperature

$\Delta dt1S5$: Temperature modification value related to DHW tank water temperature(T5)

T5	$T5 < 30^\circ C$	$30^\circ C \leq T5 < 43^\circ C$	$43^\circ C \leq T5$
$\Delta dt1S5$	6	4	0

dt1S5: Temperature difference between leaving water set temperature and tank water temperature modification value.

7.3.1.7 T4DHWMAX, T4DHWMIN

T4DHWMAX defines the ambient temperature above which the heat pump will operate in DHW mode with lowest compressor frequency.

T4DHWMIN defines the ambient temperature below which the heat pump will not operate in DHW mode.

Diagram below illustrates the effects of **T4DHWMAX** and **T4DHWMIN**.

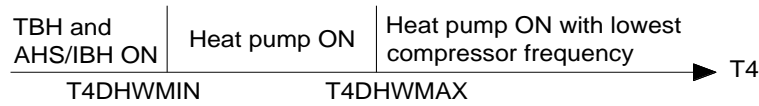

Abbreviations:

TBH: DWH tank immersion heater

AHS: Auxiliary heating source

IBH: Electric heater

7.3.1.8 t_INTERVAL_DHW

t_INTERVAL_DHW defines the delayed start-up time of compressor in DHW mode. Compressor will turn on **t_INTERVAL_DHW** minutes later after it stops last time base on system pressure equalization consideration.

7.3.1.9 ACS FUNCTION

DHW pump(Pump_D) can be installed between two tanks to equalize the tank temperature by water circulation when tank water temperature are different and DHW ON/TBH ON/Solar pump ON. In this case, two tank temperature sensors(T5_1, T5_2) are needed.

Setting	Description
1	Installation with double DHW tank.
0	Installation without double DHW tank.

7.3.2 Cooling setting

7.3.2.1 Cooling mode

Cooling mode defines whether space cooling demand is needed.

Setting	Description
1	Enable cooling mode if space cooling terminals are installed.
0	Disable cooling mode if space cooling terminals are not installed. In this case, no need to define other settings in Cooling mode .

7.3.2.2 t_T4_FRESH_C

t_T4_FRESH_C defines the refresh cycle of detecting ambient temperature for climate curve.

7.3.2.3 T4CMAX, T4CMIN

T4CMAX defines ambient temperature above which heat pump operates with lowest compressor frequency.

T4CMIN defines ambient temperature below which heat pump not operates.

Diagram below illustrates the effects of **T4CMAX** and **T4CMIN**.

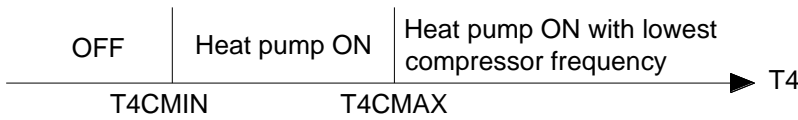

Abbreviations:

T4: Outdoor ambient temperature

7.3.2.4 dT1SC

dT1SC defines water temperature hysteresis of activating heat pump.

When $T1 - T1S \geq dT1SC$ and heat pump is within operating ambient temperature range, heat pump provides chilled water to space cooling terminals.

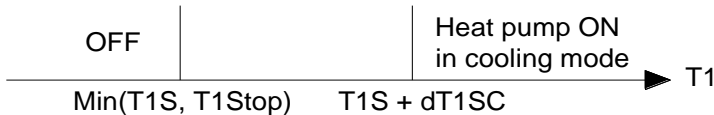

Abbreviations:

T1: Leaving water temperature

T1S: Leaving water set temperature

T1Stop: Leaving water temperature operating limit of cooling mode

7.3.2.5 dTSC

dTSC define room temperature hysteresis of activating heat pump. **dTSC** is only applicable if **1** is selected for **Room temp.** in the **1.5.3 Temp. type setting**.

When $Ta - TS \geq dTSC$ and heat pump is within operating ambient temperature range, heat pump provides chilled water to space cooling terminals.

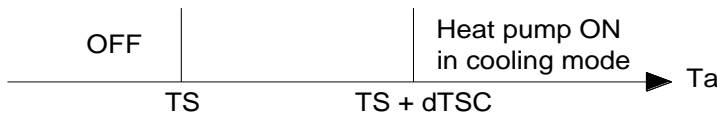

Abbreviations:

Ta: Actual room temperature

TS: Room setting temperature

7.3.2.6 t_INTERVAL_C

t_INTERVAL_C defines the delayed start-up time of compressor in cooling mode. Compressor will turn on **t_INTERVAL_C** minutes after it stops last time base on system pressure equalization consideration.

7.3.2.7 Zone 1 C-emission, Zone 2 C-emission

Zone 1 C-emission defines the terminal type of zone 1.

Setting	Description
0	Fan coil unit
1	Floor heating loop
2	Radiator

Zone 2 C-emission defines the terminal type of zone 2.

Setting	Description
0	Fan coil unit
1	Floor heating loop
2	Radiator

7.3.3 Heating setting

Heating setting		Heating setting		Heating setting	
Heating mode	1	dT1SH	5°C	Zone 2 H-emission	2
t_T4_FRESH_H	0.5hours	dTSH	2°C	Force defrost	0
T4HMAX	25°C	t_INTERVAL_H	5minutes		
T4HMIN	-15°C	Zone 1 H-emission	0		

7.3.3.1 Heating mode

Heating mode defines whether space heating demand is needed.

Setting	Description
1	Enable heating mode if space heating terminals are installed.
0	Disable heating mode if space heating terminals are not installed. In this case, no need to define other settings in Heating mode .

7.3.3.2 t_T4_FRESH_H

t_T4_FRESH_H defines the refresh time of heating mode climate temperature curve.

7.3.3.3 T4HMAX, T4HMIN

T4HMAX sets the ambient temperature above which the heat pump will operate heating mode with lowest compressor frequency.

T4HMIN sets the ambient temperature below which the heat pump will not operate in heating mode.

Diagram below illustrates the effects of T4HMAX and T4HMIN.

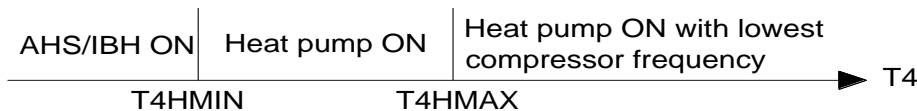

Abbreviations:

T4: Outdoor ambient temperature

7.3.3.4 dT1SH

dT1SH defines water temperature hysteresis of activating heat pump.

When $T1 \leq T1S - dT1SH$ and heat pump is within operating ambient temperature range, heat pump provides hot water to the space heating terminals.

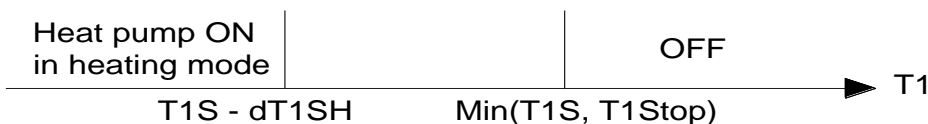

Abbreviations:

T1: Leaving water temperature

T1S: Leaving water set temperature

T1Stop: Leaving water temperature operating limit of cooling mode

7.3.3.5 dTSH

dTSH defines room temperature hysteresis of activating heat pump. **dTSH** is only applicable if **1** is selected for **Room temp.** in the **Temp. type setting**.

When $TS - Ta \geq dTSH$ and heat pump is within operating ambient temperature range, heat pump provides hot water to the space heating terminals



Abbreviations:

Ta: Actual room temperature

TS: Room setting temperature

7.3.3.6 t_INTERVAL_H

t_INTERVAL_H defines the delayed start-up time of compressor in heating mode. Compressor will turn on **t_INTERVAL_H** minutes after it stops last time base on system pressure equalization consideration.

7.3.3.7 Zone 1 H-emission, Zone 2 H-emission

Zone 1 H-emission defines the terminal type of zone 1.

Setting	Description
0	Fan coil unit
1	Floor heating loop
2	Radiator

Zone 2 H-emission defines the terminal type of zone 2.

Setting	Description
0	Fan coil unit
1	Floor heating loop
2	Radiator

7.3.3.8 Force defrost

Force defrost enable heat pump enters defrost mode by manual operation when heat pump runs for 10min and air side heat exchanger outlet temperature $T3 < 0^{\circ}\text{C}$ lasts for more than 6min.

Setting	Description
0	Disable Force defrost function
1	Enable Force defrost function

7.3.4 Auto mode setting

Auto mode setting	
T4AUTOCMIN	25°C
T4AUTOHMAN	17°C

7.3.4.1 T4AUTOCMIN, T4AUTOHMAX

T4AUTOCMIN defines the ambient temperature below which the heat pump will not provide chilled water for space cooling in auto mode.

T4AUTOHMAX defines the ambient temperature above which the heat pump will not provide hot water for space heating in auto mode.

Diagram below illustrates the effects of **T4AUTOCMIN**, **T4AUTOHMAX**, **T4CMAX** and **T4HMIN**.

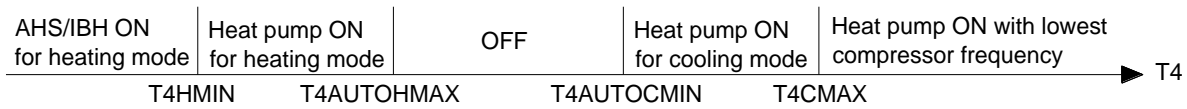

Abbreviations:

AHS: Additional heating source

IBH: Backup electric heater

T4CMAX: The ambient temperature above which heat pump operates with lowest compressor frequency.

T4HMIN: The ambient temperature below which the heat pump will not operate in heating mode.

7.3.5 Temp. type setting

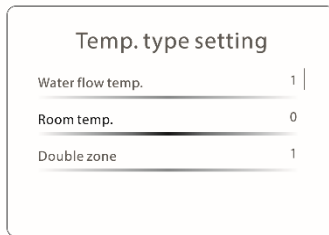

The **TEMP. TYPE SETTING** is used for selecting whether the water flow temperature or room temperature is used to control the ON/OFF of the heat pump. In this case, **7.3.6 Room thermostat setting** should be defined as 0.

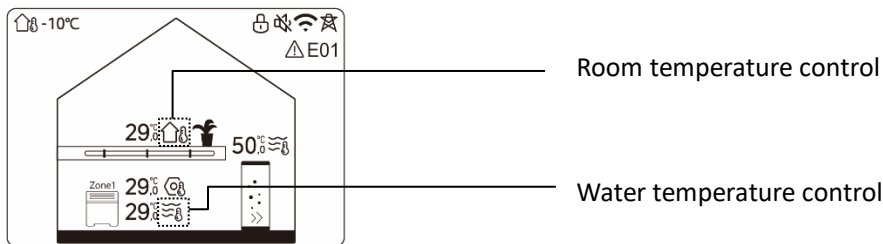

7.3.5.1 Water flow temp.

Water flow temp. defines whether heat pump is controlled by leaving water temperature.

Setting	Description
1	Heat pump is controlled by leaving water temperature.
0	Heat pump is not controlled by leaving water temperature.

7.3.5.2 Room temp.

Room temp. defines whether heat pump is controlled by room temperature detected by the temperature sensor inside the wired controller.

Setting	Description
1	Heat pump is controlled by room temperature no matter what is the setting of 7.3.5.1 Water flow temp. In this case, the target water flow temperature will be calculated from climate curves.
0	Heat pump is not controlled by room temperature.

7.3.5.3 Double zone

Double zone defines the number of zones.

Setting	Description
1	Double zones control
0	Single zone control

Figure below illustrates the effects of different combinations in **Temp. type setting**.

For single zone control

WATER FLOW TEMP.	ROOM TEMP.	DOUBLE ZONE	Zones control
1	0	0	Zone 1: Water temperature control
0	1	0	Zone 1: Room temperature control

For double zone control

WATER FLOW TEMP.		ROOM TEMP.	DOUBLE ZONE		Zones control
YES		YES	YES	NO	Zone 1: Water temperature control
YES		YES	YES	NO	Zone 2: Room temperature control
YES	NO	NO	YES		Zone 1: Water temperature control
YES	NO	NO	YES		Zone 2: Water temperature control
YES	NO	YES	YES		Zone 1: Water temperature control
YES	NO	YES	YES		Zone 2: Room temperature control

7.3.6 Room thermostat setting

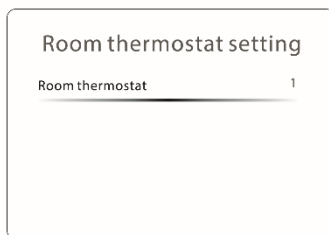

Room thermostat can be as an alternative solution to control heat pump.

Setting	Description	Wired controller is used to
0	<ul style="list-style-type: none"> NON Without room thermostats(means 1.3.5 Temp. type setting is valid) 	<ul style="list-style-type: none"> Control heat pump ON/OFF Define water temperature Define mode(heating/cooling/auto mode)
1	<ul style="list-style-type: none"> MODE SET Room thermostat provides separate heating/cooling switch signal to control heat pump ON/OFF One zone control All timers are invalid except DHW timers. 	<ul style="list-style-type: none"> Define water temperature
2	<ul style="list-style-type: none"> ONE ZONE Room thermostat provides switch signal to control heat pump ON/OFF One zone control All timers are invalid except DHW timers. 	<ul style="list-style-type: none"> Define water temperature Define mode(heating/cooling mode)
3	<ul style="list-style-type: none"> DOUBLE ZONE Room thermostat provides switch signal to control heat pump ON/OFF Double zones control All timers are invalid except DHW timers. 	<ul style="list-style-type: none"> Define water temperature Define mode(Only for heating mode)

If **Room thermostat setting** is defined as MODE SET, the interface appears:

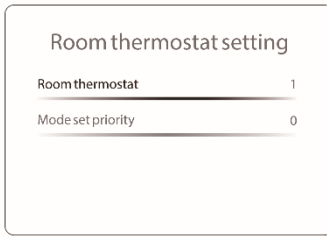

Mode set priority defines whether cooling mode or heating mode takes priority.

Setting	Description
0	When heating and cooling switch signal are closed simultaneously, heat pump runs in heating mode.
1	When heating and cooling switch signal are closed simultaneously, heat pump runs in cooling mode.

7.3.7 Other Heat Source Menu

Other heat source

IBH function 1 |

IBH locate 0

dT1_IBH_ON 5°C

t_IBH_DELAY 15minutes

Other heat source

T4_IBH_ON -5°C |

P_IBH1 0.0kW

P_IBH2 0.0kW

AHS_function 0

Other heat source

AHS_PUMPI CONTROL 0 |

dT1_AHS_ON 5°C

t_AHS_DELAY 30minutes

T4_AHS_ON -5°C

Other heat source

EnSwitchPDC 0 |

GAS-COST 0.85

ELE-COST 0.20

MAX-SETHEATER 80°C

Other heat source

MIN-SETHEATER 30°C |

MAX-SIGHEATER 10V

MIN-SIGHEATER 3V

TBH FUNCTION 1

Other heat source

dT5_TBH_OFF 5°C |

t_TBH_DELAY 30minutes

T4_TBH_ON 5°C

P_TBH 2.0kW

Other heat source

Solar function 0 |

Solar control 0

Deltatsol 10°C

7.3.7.1 IBH FUNCTION, IBH LOCATE, dT1_IBH_ON, t_IBH_DELAY, T4_IBH_ON, P_IBH1, P_IBH2

IBH FUNCTION defines backup heater function.

Setting	Description
0	IBH is used for heating mode and DHW mode
1	IBH is used for heating mode

IBH LOCATE defines backup heater/auxiliary heating source installation location

Setting	Description
0	Pipe loop

dT1_IBH_ON defines water temperature hysteresis of activating electric heater. When $T1S - T1 \geq dT1_IBH_ON$ the backup electric heater is on.

T1S: Heat pump leaving water set temperature

T1: Heat pump leaving water temperature

t_IBH_DELAY defines the delayed start-up time of electric heater. Electric heater will turn on **t_IBH_DELAY** minutes later after compressor starts.

T4_IBH_ON defines the ambient temperature below which the backup electric heater is on.

Note: Only when **dT1_IBH_ON**, **t_IBH_DELAY** and **T4_IBH_ON** are met at the same time then electric heater turns on.

Diagram below illustrates the effects of **T4_IBH_ON**, **T4HMIN** and **T4HMAX**.

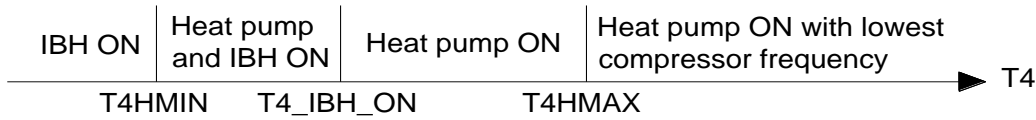

Abbreviations:

T4: Outdoor ambient temperature

IBH: Electric heater

T4HMIN: The ambient temperature below which the heat pump will not operate in heating mode.

T4HMAX: The ambient temperature above which the heat pump will operate heating mode with lowest compressor frequency.

P_IBH1 defines heating capacity of IBH1, which is used for energy consumption statistics.

P_IBH2 defines heating capacity of IBH2, which is used for energy consumption statistics.

7.3.7.2 AHS FUNCTION, AHS_PUMP_I CONTROL, dt1_AHS_ON, t_AHS_DELAY, T4_AHS_ON

AHS FUNCTION defines auxiliary heating source function.

Setting	Description
0	Without Auxiliary heating source
1	Auxiliary heating source is used for heating mode
2	Auxiliary heating source is used for heating mode and DHW mode

AHS_PUMP_I CONTROL select the Pump_I operating status when only auxiliary heating source runs.

Setting	Description
0	Pump_I runs when auxiliary heating source runs only.
1	Pump_I does not run when auxiliary heating source runs only. In this case, please confirm there is an additional pump running for auxiliary heating source.

dt1_AHS_ON defines water temperature hysteresis of activating auxiliary heating source. When $T1S - T1 \geq dt1_AHS_ON$ the additional heating source is on.

T1S: Heat pump leaving water set temperature

T1: Heat pump leaving water temperature

t_AHS_DELAY defines the delayed start-up time of auxiliary heating source. Auxiliary heating source will turn on **t_AHS_DELAY** minutes later after compressor starts.

T4_AHS_ON defines the ambient temperature below which the auxiliary heating source is on.

Note: Only when dt1_AHS_ON, t_AHS_DELAY and T4_AHS_ON are met at the same time then auxiliary heating source turns on.

Diagram below illustrates the effects of **T4_AHS_ON**, **T4HMIN** and **T4HMAX**.

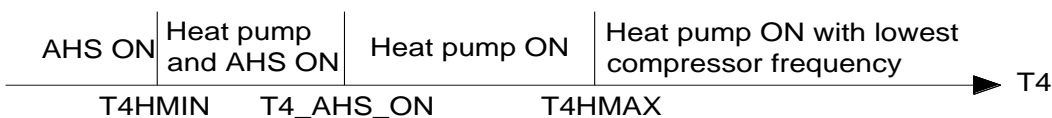

Abbreviations:

T4: Outdoor ambient temperature

AHS: Auxiliary heating source

T4HMIN: The ambient temperature below which the heat pump will not operate in heating mode.

T4HMAX: The ambient temperature above which the heat pump will operate heating mode with lowest compressor frequency.

7.3.7.3 EnSWITCHPDC, GAS_COST, ELE_COST

EnSWITCHPDC defines whether heat pump and additional heating source switch automatically based on economic performance and system high efficiency.

Setting	Description
0	Disable EnSWITCHPDC function, T4_AHS_ON need to be defined manually. Additional heating source may work with heat pump depends on the water temperature and heat pump status.
1	Enable EnSWITCHPDC function, T4_AHS_ON is calculated according to price of gas and electricity and the efficiency of boiler and heat pump. Only Additional heating source works at ambient temperature of T4_AHS_ON because of the economic performance and system high efficiency.

GAS_COST defines gas price

ELE_COST defines electricity price

7.3.7.4 MAX_SETHEATER, MIN_SETHEATER, MAX_SIGHEATER, MIN_SIGHEATER

When “AHS1” port and “AHS2” port of main control PCB are connected with auxiliary heating source “ON/OFF” signal, auxiliary heating source leaving water temperature automatically change as voltage changes.

MAX_SETHEATER sets the maximum water temperature of auxiliary heating source.

MIN_SETHEATER sets the minimum water temperature of auxiliary heating source.

MAX_SIGHEATER sets the voltage corresponding to the maximum water set temperature of auxiliary heating source.

MIN_SIGHEATER sets the voltage corresponding to the minimum water set temperature of auxiliary heating source.

Diagram below illustrates the effects of **MAX_SETHEATER**, **MIN_SETHEATER**, **MAX_SIGHEATER** and **MIN_SIGHEATER**.

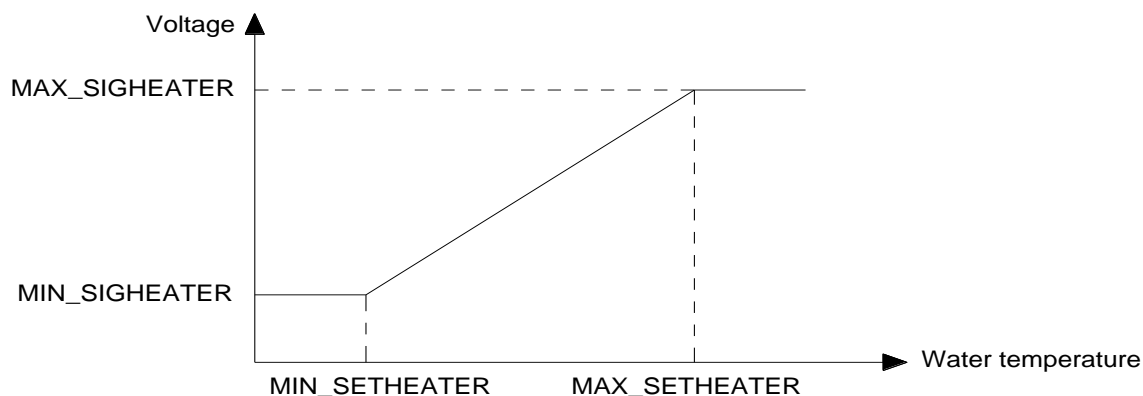

7.3.7.5 TBH FUNCTION, dt5_TBH_OFF, t_TBH_DELAY, T4_TBH_ON, P_TBH

TBH FUNCTION defines whether tank booster heater function is activated.

Setting	Description
0	Disable tank booster heater function
1	Enable tank booster heater function

dt5_TBH_OFF defines water temperature hysteresis of inactivating tank booster heater when heat pump malfunctions.

When $T5 > \text{Min}(T5S + dt5_TBH_OFF, 70^\circ\text{C})$, the tank booster heater is off.

T5S: Domestic hot water tank set temperature

t_TBH_DELAY defines the delayed start-up time of tank booster heater. Tank booster heater will turn on **t_TBH_DELAY** minutes later after compressor starts.

T4_TBH_ON defines the ambient temperature below which the tank booster heater is on.

Note: Only when **t_TBH_DELAY**, **T4_TBH_ON** are met at the same time then tank booster heater turns on.

P_TBH defines the power input of tank booster heater.

Diagram below illustrates the operation of heat pump and tank booster heater of DHW mode.

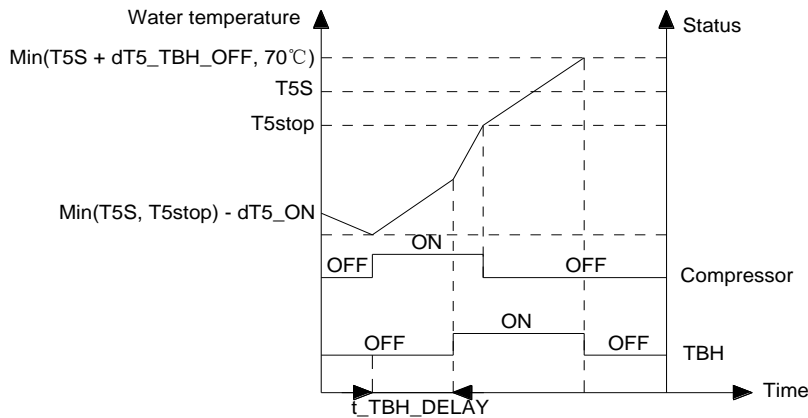

Abbreviations:

T5S: DHW set temperature

T5stop: DHW mode leaving water temperature operating limit

TBH: Immersion heater

7.3.7.6 Solar function, Solar control, Deltasol

Solar function defines whether the heating system is equipped with solar function.

Setting	Description
0	Without solar function.
1	With only solar function.
2	With solar function and heat pump.

Solar control defines the control type of solar pump

Setting	Description
0	Solar pump(Pump_S) is controlled by solar temperature sensor
1	Solar pump(Pump_S) is controlled by SL1SL2 signal

Deltasol defines temperature hysteresis of activating solar pump(Pump_s).

When $T_{solar} > T5 + \text{Deltasol}$, $T5 < 79^\circ\text{C}$ and DHW mode is ON, then solar pump activates.

7.3.8 Holiday away setting

Holiday away setting	
T1S_H.A.H	25°C
T5S_H.A.DHW	25°C

7.3.8.1 T1S_H.A._H, T5S_H.M_DHW

Holiday away setting is used to set the outlet water temperature to prevent water pipes freezing when away from home in cold weather seasons.

T1S_H.A._H defines heat pump leaving water temperature for space heating mode during holiday away mode.

T5S_H.M_DHW defines domestic hot water tank temperature for DHW mode during holiday away mode.

7.3.9 Service call

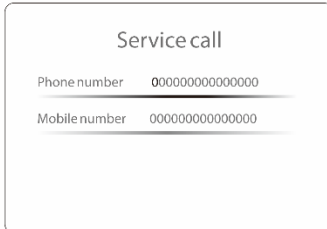

Phone number and **Mobile number** define after-sales service contact numbers. Press < > to navigate cursor and press ^ v to adjust the numerical values. The maximum length of the phone numbers is 13 digits.

7.3.10 Restore factory settings



Restore factory settings is used to restore all the parameters set in the user interface to factory defaults. On selecting YES, the process of restoring all settings to factory defaults begins and progress is displayed as a percentage.

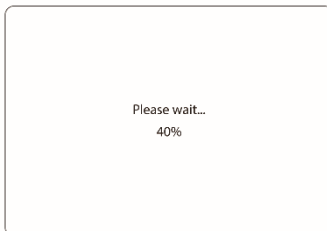

7.3.11 Test run

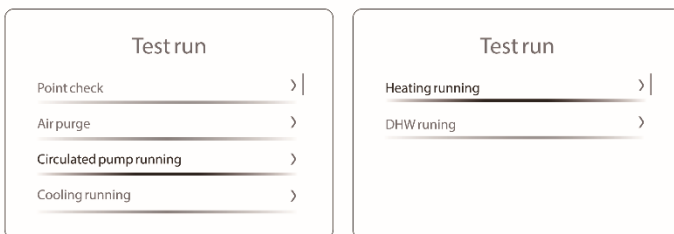

Test run is used to do the point check and check that air purge function, circulation pump, cooling mode, heating mode and DHW mode are all operating correctly. If any error code is displayed during the test run operation, the cause should be investigated.

During test run, all buttons except ○ are invalid. If you want to turn off the test run, please press ○. For example, when the unit is in air purge mode, after you press ○, the following page will be displayed:

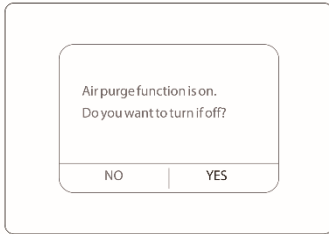

7.3.11.1 Point check

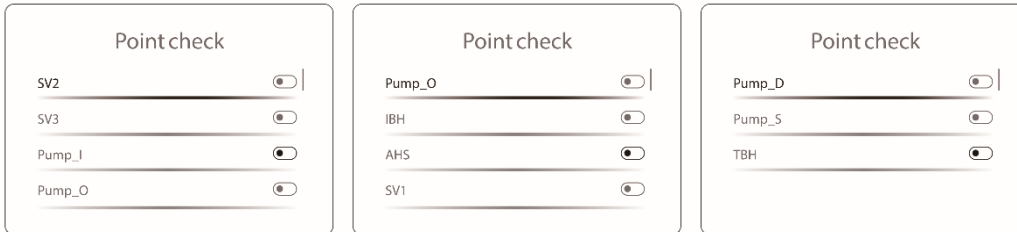

The **POINT CHECK** menu is used to check the operation of individual components. Use \wedge \vee to scroll to the components you want to check and press \odot to toggle the on/off state of the component. If a valve does not turn on/off or a pump/heater does not operate when their on/off state is toggled, please check the connection between component and main PCB and make sure components' status is normal.

7.3.11.2 Air purge

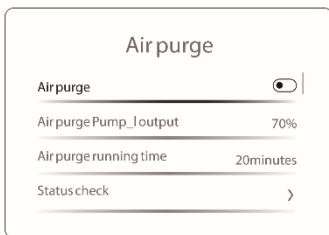

Once installation is complete, it is important to run the air purge function to remove any air which may be present in the water piping and which could cause malfunctions during operation. Before running **Air purge** mode, make sure that the air purge valve is open. Pump_I will run according to the output and running time that has been set.

Air purge defines whether the function is activated.

Air purge Pump_I output defines the Pump_I output capacity.

Air purge running time defines the period that Pump_I operates during the air purge process.

Status check allows installers to check the real-time operation parameters of air purge operation.

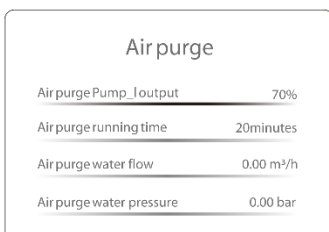

7.3.11.3 Circulated pump running

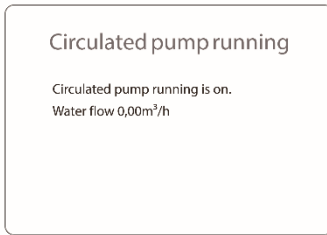

Circulated pump running operation is used to check the operation of the circulation pump.

When circulation pump running is turned on, all running components will stop.

60 seconds later, the SV1 will be off, the SV2 will be on.

60 seconds later Pump_I will operate.

30s later, if the flow switch checked normal flow, PUMP_I will operate for 3min.

After the pump stops 60 seconds, the SV1 will close and the SV2 will be off.

60s later the both PUMP_I and PUMP_O will operate.

2 mins later, the flow switch will check the water flow.

If the flow switch closes for 15s, PUMP_I and PUMP_O will operate until the next command is received.

7.3.11.4 Cooling running

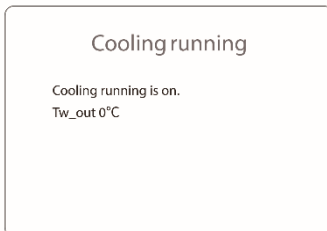

The **Cooling running** operation is used to check the operation of the system in space cooling mode.

During the **Cooling running** operation, the leaving water set temperature is 7°C. The current actual leaving water temperature is displayed on the user interface. The unit operates until the leaving water temperature drops to the set temperature or the next command is received.

7.3.11.5 Heating running

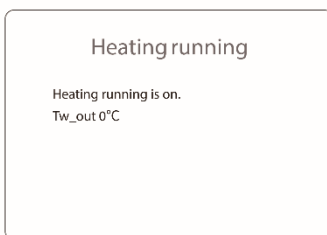

The **Heating running** operation is used to check the operation of the system in space heating mode.

During **Heating running** test running, the default target outlet water temperature is 35°C. The IBH (backup heater) will turn on after the compressor runs for 10 min. After the IBH runs for 3 minutes, the IBH will turn off. Heat pump will operate until the water temperature increase to a certain value or the next command is received.

7.3.11.6 DHW running

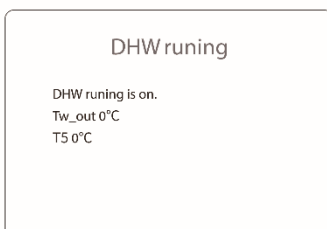

The **DHW running** operation is used to check the operation of the system in DHW mode.

During **DHW running** test running, the default target temperature of the domestic water is 55°C. The TBH (tank boost heater) will turn on after the compressor runs for 10min. The TBH will turn off 3 minutes later. Heat pump will operate until the water temperature increase to a certain value or the next command is received.

7.3.12 Special Function

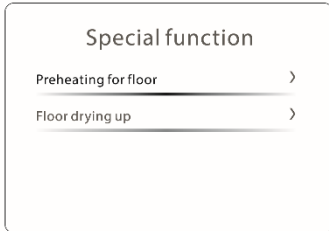

7.3.12.1 Preheating for floor

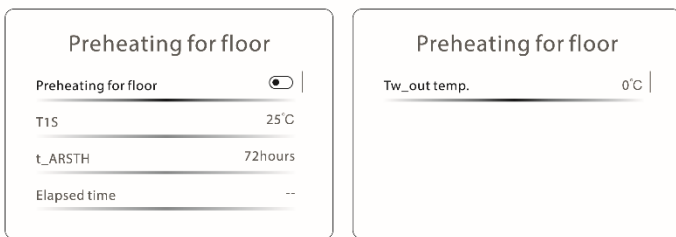

Preheating for floor function provides mild heat to the underfloor water piping for the first time during seasonal heating, diminish the risk of damage to the floor and piping system.

Setting	Description
0	Disable preheating for floor function
1	Enable preheating for floor function

T1S defines heat pump leaving water temperature in preheating.

T_ARSTH defines running time for first preheating of the floor

Elapsed time is the period that **Preheating for floor function** had run.

Tw_out temp. is the current leaving water temperature

Diagram below illustrates the operation of **Preheating for floor** function.

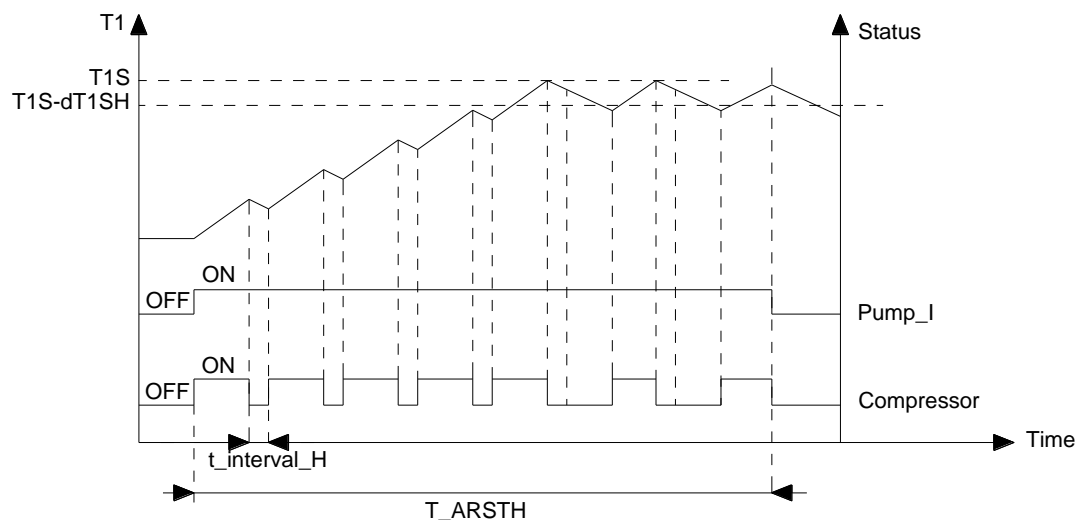

Abbreviations:

- T1: Leaving water temperature
- dT1SH: Water temperature hysteresis of activating heat pump.
- t_interval_H: The delayed start-up time of compressor in heating mode.

7.3.12.2 Floor drying up

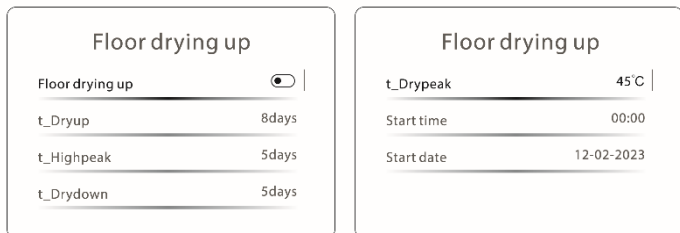

For newly-installed under-floor heating systems, floor drying up is necessary to remove moisture from the floor slab and subfloor to prevent warping or rupture of the floor. Heat pump provides mild heat to the concrete or other structural material around the underfloor water piping in a certain period of time, accelerate the process of getting rid of moisture. During floor drying up operation, the temperature of the floor would be increased gradually. In the event of a heat pump malfunction, floor drying up mode will continue if a backup electric heater and/or auxiliary heating source is available and configured to support space heating mode.

There are three phases to the floor drying up operation:

- Phase 1: gradual temperature increase to the peak temperature
- Phase 2: maintain peak temperature
- Phase 3: gradual temperature decrease from the peak temperature

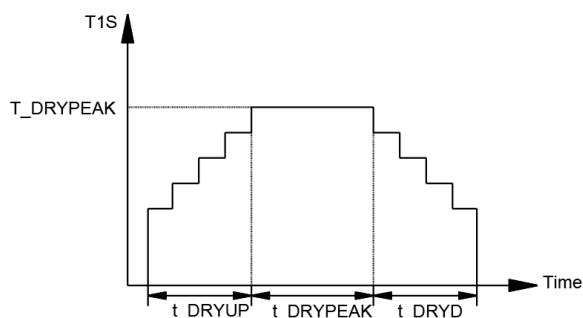

Floor drying up

Setting	Description
0	Disable floor draying up function
1	Enable floor draying up function

t_Dryup defines the duration of Phase 1.

t_Highpeak defines the duration of Phase 2.

t_Drydown defines the duration of Phase 3.

t_Drypeak defines the heat pump leaving water temperature of Phase 2.

Start time defines the floor drying up operation start time.

Start date defines the floor drying up operation start date.

7.3.13 Auto restart

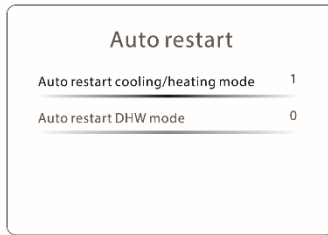

Auto restart sets whether or not the unit re-applies the mode and unit status settings when the power returns following a power failure.

If **7.3.6 Room thermostat setting** is defined as not 0, **Auto restart function** will not be applicable.

Auto restart cooling/heating mode

Setting	Description
0	Disable auto restart cooling/heating mode
1	Enable auto restart cooling/heating mode

Auto restart DHW mode

Setting	Description
0	Disable auto restart DHW mode
1	Enable auto restart DHW mode

7.3.14 Power input limitation

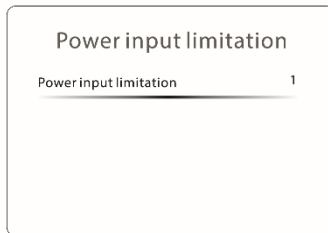

Power input limitation makes the machine suitable for a variety of current supplies. There are 8 configurations for user to choose according to the maximum allowable access current. If the unit will operate at larger current input, 1 should be selected. If the unit will operate at a lower current input, 2-8 should be selected and the power input and capacity will decrease.

Power limitation function

Setting	Model			
	4kW 6kW	8kW 10kW	Single phase 12~16kW	Three phase 12~16kW
1	13.5A	17.5A	28A	9.5A
2	12A	16A	26A	8.5A
3	11A	15A	24A	7.5A
4	10A	14A	22A	7A
5	9A	13A	20A	6.5A
6	8A	12A	18A	6A
7	8A	12A	18A	6A
8	8A	12A	18A	6A

7.3.15 Input definition

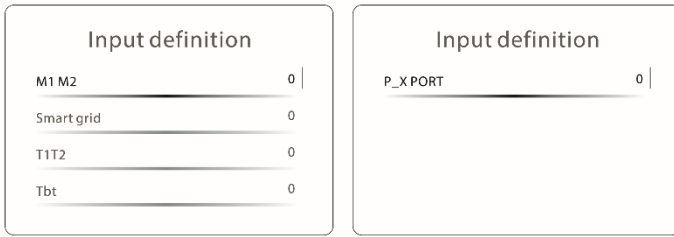

INPUT DEFINE defines sensors and functions to fulfill with installation.

M1 M2 defines the function of M1M2 port

Setting	Description
0	Remote ON/OFF control of heat pump
1	Remote ON/OFF control of tank booster heater
2	Remote ON/OFF control of auxiliary heating source

Smart grid defines whether SMART GRID control signal is connected to hydronic PCB.

Setting	Description
0	Disable Smart grid function
1	Enable Smart grid function

T1T2 defines control options of Port T1T2

Setting	Description
0	Installation with MH-kit
1	Installation without MH-kit

Tbt defines whether balance tank temperature sensors are installed in the balance tank.

Setting	Description
0	Installation with balance tank temperature sensor(Tbt)
1	Installation without balance tank temperature sensor(Tbt)

P_X PORT can be defined as defrosting signal or alarm signal according to customers' demand.

Setting	Description
0	Defrosting signal
1	Alarm signal

7.3.16 Cascade setting

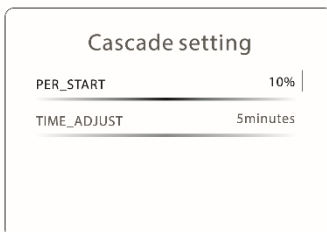

PER_START sets the start-up percentage of multiple units for the first time start-up after power on. For example:

Total units	PER_START	Starting units
6	50%	3
6	30%	2

TIME_ADJUST sets the judgment period of adding and subtracting units

7.3.17 HMI address setting

HMI address setting	
HMI setting	0
HMI address for BMS	1
Stop BIT	1

HMI setting sets the wired controller is master or slave. (0=MASTER, 1=SLAVE)

When HMI SET is set to SLAVE, the controller can only switch the operation mode, turn on or off, set the temperature, and cannot set other parameters and functions.

Setting	Description
0	Define wired controller as master controller.

HMI ADDRESS FOR BMS sets the HMI address code for BMS.(only valid for master controller)

STOP BIT set upper computer stop bit(1: STOP BIT1; 2:STOP BIT2)

Setting	Description
1	Stop bit 1
2	Stop bit 2

7.3.18 Common setting

Common setting	
t_DELAY PUMP	20minutes
t1_ANTILOCK PUMP	24hours
t2_ANTILOCK PUMP RUN	60seconds
t1-ANTILOCK SV	24hours

Common setting	
t2-ANTILOCK SV RUN	2.0minutes
Ta-adj.	-2°C
F-PIPE LENGTH	0
PUMP_I SILENT OUTPUT	100%

Common setting	
Energy metering	1
Pump_O	0

7.3.18.1 t_DELAY PUMP

t_DELAY PUMP defines the delayed stop time of Pump_I. Pump_I will stop **t_DELAY PUMP** minutes later after compressor stops base on system temperature equalization consideration.

7.3.18.2 t1_ANTILOCK PUMP, t2_ANTILOCK PUMP RUN, t1_ANTILOCK SV, t2_ANTILOCK SV RUN

Antilock operation prevent components from sticking to result in system fail.

t1_ANTILOCK PUMP defines the interval time that Pump_I, Pump_O and Pump_C runs in order to antilock

t2_ANTILOCK PUMP RUN defines the running time for Pump_I, Pump_O and Pump_C antilock operation

t1_ANTILOCK SV defines the interval time that SV1, SV2 and SV3 valve works in order to antilock

t2_ANTILOCK SV RUN defines the running time for SV1, SV2 and SV3 valve antilock operation

7.3.18.3 Ta-adj

Ta-adj is an correction value for room temperature sensor(Ta) which is inside the wired controller. The display room temperature value is equal to Ta + **Ta-adj**.

7.3.18.4 F-PIPE LENGTH

F-PIPE LENGTH select the total length of the liquid pipe.

Setting	Description
0	Total length of the liquid pipe < 10m
1	Total length of the liquid pipe \geq 10m

7.3.18.5 PUMP_I_SILENT OUTPUT

PUMP_I_SILENT OUTPUT can decrease water pump maximum output in order to decrease the noise of heat pump.

7.3.18.6 Energy metering

Energy metering allows user to check energy data of day, week, month and year.

Setting	Description
0	Disable energy metering function
1	Enable energy metering function

7.3.18.7 Pump_O

Pump_O defines Zone 1 pump(**Pump_O**) control type.

Setting	Description
0	Pump_O keeps running
1	Pump_O operation is controlled by heat pump

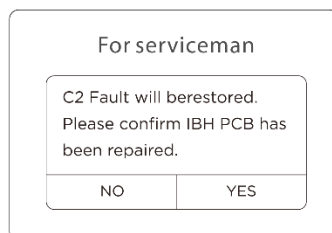
7.3.19 C2 fault restore

For the unit with IBH(internal backup heater), when C2 error occurs, please follow C2 troubleshooting guide of Part4 Diagnosis and Troubleshooting. If necessary, select YES to restore C2 code.

7.4 Operation parameter

Operation parameter is for reviewing the operation parameters. The interface below is for reference and different units' state correspond to different parameter values.

Operation for entering **Operation parameter**:

Step 1: Home page

Step 2: Press “≡”

Step 3: Select “Unit status”

Step 4: Select “Operation parameter”

Step 5: Press ○

Operation parameter

Unit NO.	Parameter	Value
#00 1	Online unit number	1
#00 2	ODU unit	5Kw
#00 3	Operating	Heating
#00 4	Operation status	ON

Operation parameter

Unit NO.	Parameter	Value
#00 5	Frequency limited type	--
#00 6	Comp. run time	5minutes
#00 7	Comp. frequency	20Hz
#00 8	Fan speed	400RPM

Operation parameter

Unit NO.	Parameter	Value
#00 9	Expansion valve	70P
#00 10	Tp comp. discharge temp.	50°C
#00 11	Th comp. suction temp.	50°C
#00 12	T3 outdoor exchanger temp.	50°C

Operation parameter

Unit NO.	Parameter	Value
#00 13	T4 outdoor air temp.	50°C
#00 14	TF module temp.	50°C
#00 15	P1 comp. pressure	100kPa
#00 16	P2 comp. pressure	100kPa

Operation parameter

Unit NO.	Parameter	Value
#00 17	T2BplateF-in temp.	50°C
#00 18	T2plateF-out temp.	50°C
#00 19	Tw_in plate water inlet temp.	50°C
#00 20	Tw_out plate water outlet temp.	50°C

Operation parameter

Unit NO.	Parameter	Value
#00 21	T1 leaving water temp.	50°C
#00 22	Tw2 circuit2 water temp.	50°C
#00 23	Ta room temp.	50°C
#00 24	RH room humidity	50°C

Operation parameter

Unit NO.	Parameter	Value
#00 25	T5 water tank temp.	50°C
#00 26	T5_2 water tank temp.	50°C
#00 27	TBt buffer tank temp.	50°C
#00 28	Tsolar	50%

Operation parameter

Unit NO.	Parameter	Value
#00 29	T1S_C1 CLI. curve temp.	50°C
#00 30	T1S2_C2 CLI. curve temp.	50°C
#00 31	Water pressure	1bar
#00 32	Water flow	1m/h

Operation parameter

Unit NO.	Parameter	Value
#00 33	Heat pump capacity	10kW
#00 34	ODU current	1A
#00 35	ODU voltage	220V
#00 36	DC voltage	110V

Operation parameter

Unit NO.	Parameter	Value
#00 37	DC current	5A
#00 38	Power consump.	10kWh
#00 39	SV1	OFF
#00 40	SV2	OFF

Operation parameter

Unit NO.	Parameter	Value
#00 41	SV3	OFF
#00 42	Pump_I	OFF
#00 43	Pump_O	OFF
#00 44	Pump_C	OFF

Operation parameter

Unit NO.	Parameter	Value
#00 45	Pump_S	OFF
#00 46	Pump_D	OFF
#00 47	IBH1	OFF
#00 48	IBH2	OFF

Operation parameter

Unit NO.	Parameter	Value
#00 49	TBH	OFF
#00 50	AHS	OFF
#00 51	Comp. total run time	100h
#00 52	Fan total run time	100h

Operation parameter

Unit NO.	Parameter	Value
#00 53	Pump_I total run time	100h
#00 54	IBH total run time	100h
#00 55	IBH2 total run time	100h
#00 56	TBH total run time	100h

Operation parameter

Unit NO.	Parameter	Value
#00 57	AHStotal run time	100h
#00 58	IDU software	01-01-2023V01
#00 59	ODU software	01-01-2023V01
#00 60	HMI software	01-01-2023V01

Operation parameter

Unit NO.	Parameter	Value
#00 61	Pump_IPWM	70%

8 USB Function Field Settings

USB function helps you to transmit parameters and program easily. When USB disk connect to CN4 port of main control PCB, the USB function interface appears automatically on the wired controller.

Main control PCB



CN4 USB port

USB function interface

Sub-function 1:
Copy setting parameters from wired controller to USB disk

Sub-function 2:
Paste setting parameters from USB disk to wired controller

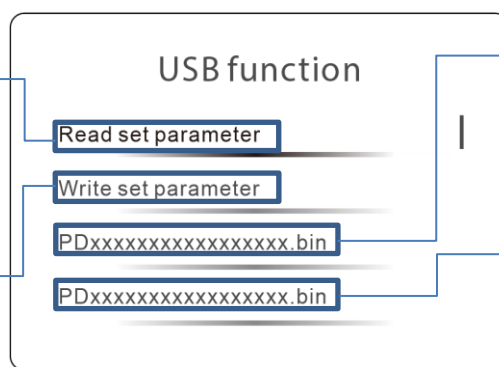

Sub-function 3:
Paste hydraulic system program

Sub-function 4:
Paste refrigerant system program

Sub-function 1:

Once the process finishes successfully, the parameter file “M_Thermal_Config(Prohibit to rewrite).csv” will be generated in the USB disk. If you want to change the parameter on computer, please remember only change the value of column C (red frame below) is allowed and do not change any other content or the file name.

Index	Parameter Name	Value
3	dT5_on	5
4	t_interval_DHW	5

Sub-function 2:

Please make sure there is only one parameter file in the USB disk before using this function.

Sub-function 3:

Please make sure there is only one applicable hydraulic system program in the USB disk before using this function.

Sub-function 4:

Please make sure there is only one applicable refrigerant system program in the USB disk before using this function.

Press \wedge \vee to choose the item and press \circ to confirm your choice, then the rate of process appears like below:

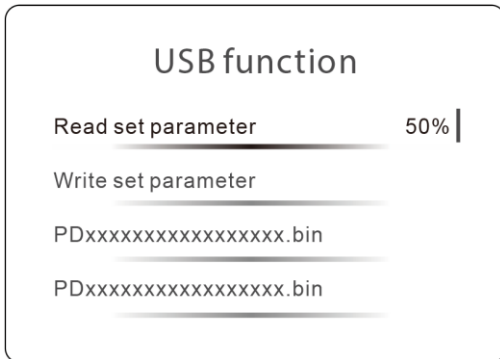

During the process, all the buttons are invalid.

When the process finishes, pop-up window with "Success" cue word appears briefly and unit stops. Please remove the USB disk and restart the unit.

When the process fails, pop-up window with "Fail" cue word appears briefly. The system program remains unchanged.

If the stalled process happens, please remove the USB disk and try to insert the USB disk according to operation above.

Part 4

Diagnosis and Troubleshooting

1 Service Information.....	62
2 Electric wiring diagram	66
3 Electric Control Box Layout	70
4 Outdoor Unit PCBs	73
5 Error Code Table	83
6 Troubleshooting	86
7 Discharge / Suction pressure and temperature range	145
8 Appendix to Part 4	146

1 Service Information

DANGER !

- These instructions are exclusively intended for qualified contractors and authorised installers
- Work on the refrigerant circuit with flammable refrigerant in safety group A2L may only be carried out by authorised heating contractors. These heating contractors must be trained in accordance with EN 378 Part 4 or IEC 60335-2-40, Section HH. The certificate of competence from an industry accredited body.
- Brazing/soldering work on the refrigerant circuit may only be carried out by contractors certified in accordance with ISO 13585 and AD 2000, Datasheet HP 100R. And only by contractors qualified and certified for the processes to be carried out. The work must fall within the range of applications purchased and be carried out in accordance with the prescribed procedures. Soldering/brazing work on accumulator connections requires certification of personnel and processes by a notified body according to the Pressure Equipment Directive (2014/68/EU).
- Work on electrical equipment may only be carried out by a qualified electrician.
- Before initial commissioning, all safety relevant points must be checked by the particular certified heating contractors. The system must be commissioned by the system installer or a qualified person authorised by the installer.

1.1 Label for Refrigerant Presence

Equipment should be provided with a label stating that it has been de-commissioned and emptied of refrigerant. The label should be dated and signed. Ensure that proper labels are pasted on the equipment stating the equipment contains flammable refrigerant

1.2 Leak Detection Methods

The following leak detection methods are deemed acceptable for systems containing flammable refrigerants. An electronic leak detector should be used to detect flammable refrigerants, but its sensitivity may not be adequate, or the detector may need re-calibration. (Detection equipment should be calibrated in a refrigerant-free area.) Ensure that the detector is not a potential source of ignition and is suitable for the refrigerant. Leak detection equipment should be set at a percentage of the LFL of the refrigerant and should be calibrated to be suitable for the refrigerant employed. The appropriate percentage of gas (25% maximum) is confirmed. Leak detection fluids are suitable for use with most refrigerants but detergents containing chlorine should not be used as the chlorine may react with the refrigerant and corrode the copper pipes. If a leak is suspected, all naked flames should be removed or extinguished. If a leakage of refrigerant is found and brazing is required, all of the refrigerant should be recovered from the system, or isolated (by means of shut off valves) in a part of the system that is remote from the leak. Oxygen free nitrogen (OFN) should then be purged through the system both before and during the brazing process.

1.3 Check of Refrigeration Equipment

Where electrical components are to be changed, they should be fit for the intended purpose and comply with the correct specifications. Always follow the manufacturer's maintenance and service guidelines. In case of any doubt, consult the manufacturer's technical department for assistance. Check installations using flammable refrigerants.

- The amount of refrigerant to be charged depends on the size of the room where the refrigerant-containing parts are installed.
- The ventilation machinery and outlets should work adequately and be not obstructed.
- If an indirect refrigerating circuit is used, the secondary circuits should be checked for any refrigerant; Markings on the equipment should be visible and legible.
- Illegible markings and signs should be corrected.
- Refrigeration pipes or components should be installed in a positions where they are unlikely to be exposed to any

substance that may corrode refrigerant-containing components, unless the components are constructed of materials that are inherently resistant to corrosion or are suitably protected from corrosion

1.4 Check of Electrical Devices

Repair and maintenance of electrical components should include initial safety checks and component inspection procedures. If a fault exists and could compromise safety, no electrical supply should be connected to the circuit until it is satisfactorily dealt with. If the fault cannot be corrected immediately but it is necessary to continue operation, an adequate temporary solution should be adopted. This should be reported to the owner of the equipment so all parties are advised. Repair and maintenance of electrical components should include initial safety checks and component inspection procedures. If a fault exists and could compromise safety, no electrical supply should be connected to the circuit until it is satisfactorily dealt with. If the fault cannot be corrected immediately but it is necessary to continue operation, an adequate temporary solution should be adopted. This should be reported to the owner of the equipment so all parties are advised. Initial safety checks should include the following:

- The capacitors should be discharged in a safe manner to avoid sparking risks
- No live electrical components and wiring can be exposed during the system charging, recovery or purging. Earth bonding should be continuous
- Earth bonding should be continuous

1.5 Repair of Sealed Components

1. During repair of sealed components, all electrical supplies should be disconnected from the equipment being worked upon prior to any removal of sealed covers. If it is absolutely necessary to have an electrical supply connected with the equipment during servicing, a permanently operating form of leak detection should be located at the most critical point to warn of a potentially hazardous situation.
2. Particular attention should be paid to the following to ensure that, by working on electrical components, the casing is not altered in such a way that the protection is compromised. This should include damage to cables, an excessive number of connections, terminals not made as per original specifications, damage to seals, and incorrect fitting of glands.
 - Ensure that all apparatuses are mounted securely.
 - Ensure that seals or sealing materials have not degraded such that they can no longer prevent the ingress of flammable atmospheres. Parts for replacement should be in accordance with the manufacturer's specifications.
 - The use of silicon sealant may inhibit the effectiveness of some types of leak detection equipment. Intrinsically safe components do not have to be isolated prior to working on them.

1.6 Repair of Intrinsically Safe Components

Do not apply any permanent inductive or capacitance loads to the circuit without ensuring that such loads will not exceed the permissible voltage or current permitted for the equipment in use. Intrinsically safe components are the only types that can be worked on when the components live in a flammable atmosphere. The test apparatus should be provided with the correct rating. Replace components only with parts specified by the manufacturer. Other parts may result in the ignition of refrigerant in the atmosphere caused by a leak.

1.7 Transportation and Marking

Transport the equipment containing flammable refrigerants in accordance with the transport regulations. Mark the equipment with signs in compliance with local regulations.

1.8 Disposal

1.8.1 General

- Components and accessories of the unit are not ordinary domestic wastes.
- The unit, compressors, and motors, etc. can only be disposed of by qualified specialists.

- This unit uses hydrofluorocarbon that can only be disposed of by qualified specialists

1.8.2 Packaging

- Dispose of the packaging properly.
- Observe all relevant regulations



1.8.3 Refrigerant Removal, Evacuation, Charge, Recovery, and Unit Decommissioning

WARNING !

Due to the feature of the R290 refrigerant, only carry out work when you have specific expert refrigeration knowledge and are competent for handling R290 refrigerant.

1.8.3.1 Removal and evacuation

When breaking into the refrigerant circuit for repair or any other purpose, follow the conventional procedures. However, it is important to follow the best practice since flammability should be considered. Operate as per the following procedure:

- Remove refrigerant;
- Purge the circuit with inert gas;
- Evacuate;
- Purge the circuit again with inert gas;
- Open the circuit by cutting or brazing

The refrigerant charged should be recovered and put in correct recovery cylinders. The system should be flushed with OFN to guarantee the unit safety. This process may need to be repeated several times. Compressed air or oxygen should not be used.

Flushing should be achieved by filling the system with OFN until the working pressure is achieved before venting to the atmosphere, and recovering the system to a vacuum. This process should be repeated until no refrigerant exists in the system. Upon the final OFN charge, the system should be vented down to reach the atmospheric pressure to start the work.

This operation is absolutely vital if brazing operations on the pipe-work are to take place.

Ensure that the outlet of the vacuum pump is not closed to any ignition sources and adequate ventilation is available.

1.8.3.2 Charging procedures

In addition to conventional charging procedures, the following requirements should be followed:

- Ensure that contamination of different refrigerants does not occur when charging equipment is used. Hoses or lines should be as short as possible to minimize the amount of refrigerant contained in them.
- Earth the refrigeration system prior to charging the system with refrigerant.
- Label the system upon completion of the charging (if the system has not been labeled).
- Extreme care should be taken not to overfill the refrigeration system.
- Prior to recharging the system, test it with OFN. The system should be leak tested upon completion of charging but prior to commissioning. Carry out a follow-up leak test before leaving the site.

1.8.3.3 Recovery

When removing refrigerant from the system, either for service or decommissioning, we recommend you remove all refrigerants safely by following the best practice.

When transferring refrigerant into cylinders, only use appropriate refrigerant recovery cylinders. Ensure that a proper number of cylinders are available for accommodating all the refrigerant. All cylinders to be used are designated and labeled for the recovered refrigerant (i.e., special cylinders for the recovery of refrigerant). The cylinders should be complete with pressure relief valves and associated shut-off valves that work properly.

Empty recovery cylinders should be evacuated and, if possible, cooled before the recovery starts.

The recovery equipment should work properly with a set of instructions concerning the equipment at hand, and should be suitable for the recovery of flammable refrigerants. In addition, a set of calibrated weighting scales should be available and work properly. Hoses should be complete with leak-free disconnection couplings and in good conditions. Before using the

recovery equipment, check and verify that it works properly and has been properly maintained, and that any associated electrical components are sealed to prevent ignition in the event of a refrigerant leakage. Consult the manufacturer in case of any doubt.

The recovered refrigerant should be returned to the refrigerant supplier in correct recovery cylinders, with the relevant Waste Transfer Note arranged. Do not mix refrigerants in recovery units, especially in cylinders.

If compressors or compressor oils are to be removed, ensure that they have been evacuated to an acceptable level to ensure that flammable refrigerant does not remain within the lubricant. Carry out the evacuation process before returning the compressor to the suppliers. To accelerate this process, you can only heat the compressor body electrically. Safety drain oil from the system.

1.8.3.4 Decommissioning

Prior to this procedure, the technician should be completely familiar with the equipment and all its details. It is recommended that all refrigerants be recovered safely. Prior to the recovery, an oil and refrigerant sample should be taken for case analysis before re-use of reclaimed refrigerant. Electrical power should be available before the task is commenced.

1. Be familiar with the equipment and its operation.
2. Isolate the system electrically
3. Before attempting the procedure ensure that:
 - Mechanical handling equipment is available, if required, for handling refrigerant cylinders.
 - All personal protective equipment should be available and used correctly.
 - The recovery process should be supervised at all time by a competent person.
 - Recovery equipment and cylinders should conform to the appropriate standards.
4. Pump down the refrigerant system, if possible.
5. If a vacuum is not possible, provide a manifold to remove the refrigerant from various parts of the system.
6. Make sure that the cylinders are situated on the scales before the recovery starts.
7. Start the recovery machine and operate it in accordance with the manufacturer's instructions.
8. Do not overfill the cylinders (for no more than 80% of the volume).
9. Do not exceed the maximum working pressure of the cylinders, even temporarily.
10. When the cylinders have been filled correctly and the process is completed, immediately remove the cylinders and the equipment from the site and close all isolation valves on the equipment.
11. The recovered refrigerant should not be re-used in any other refrigeration system unless it has been cleaned and checked.

2 Electric wiring diagram

1Ph 4-16kW

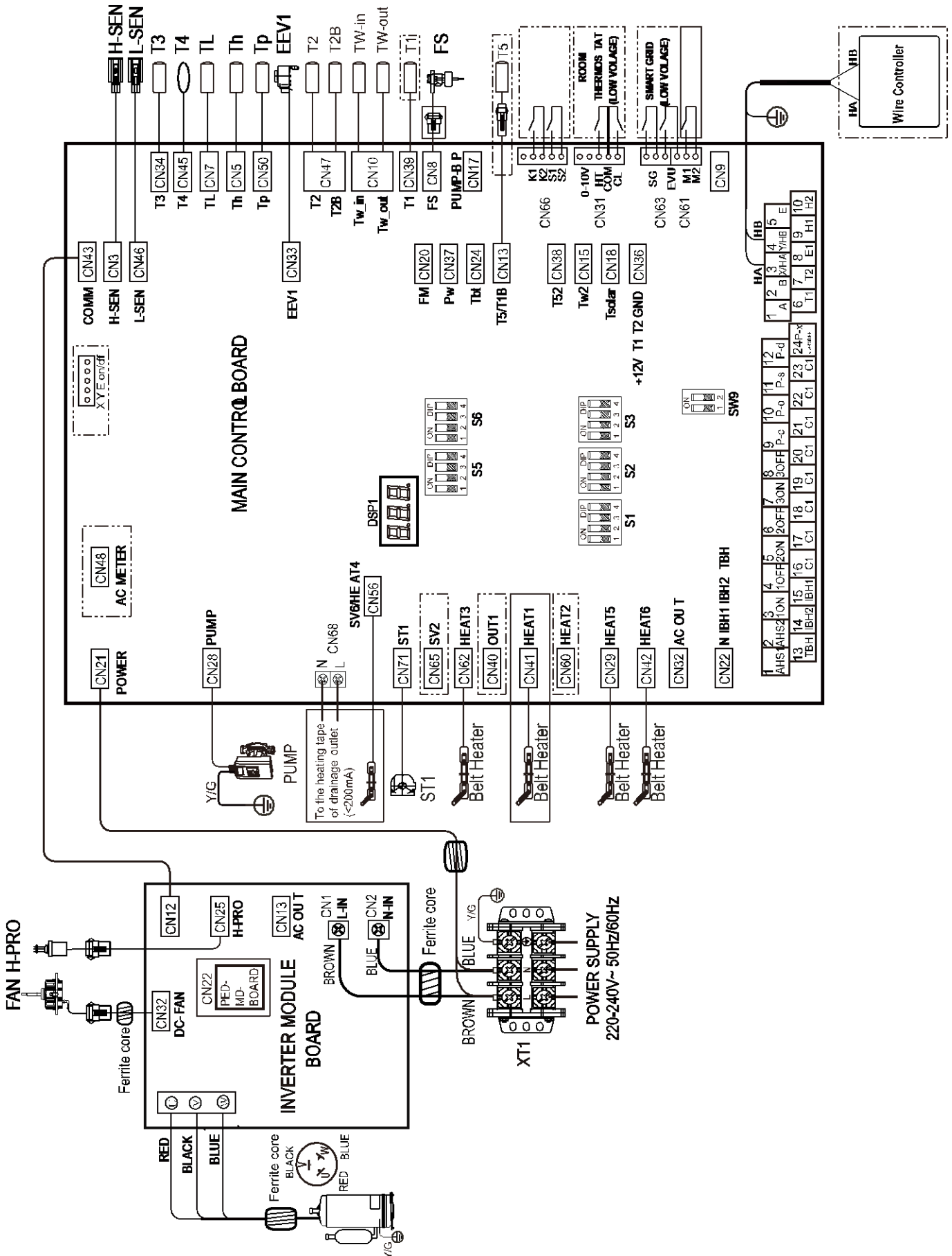

3kW IBH(One step control)

! Leakage Protection Switch must be installed to the Power Supply of the unit.
Equipment must be grounded.

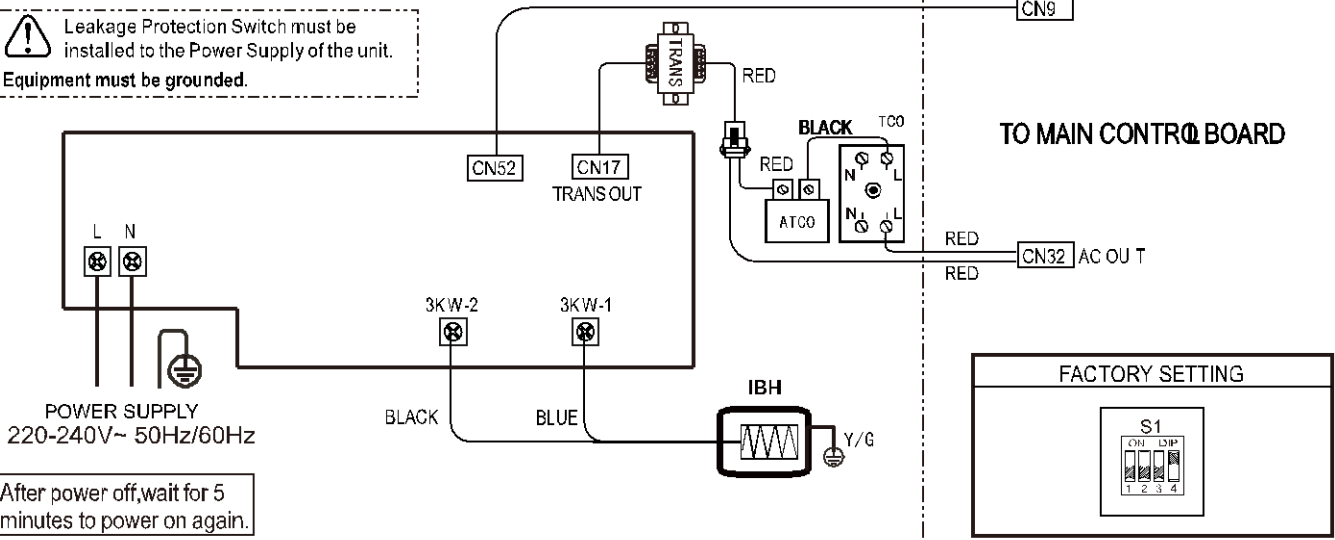

After power off, wait for 5 minutes to power on again.

9kW IBH(Three step control)

! Leakage Protection Switch must be installed to the Power Supply of the unit.
Equipment must be grounded.

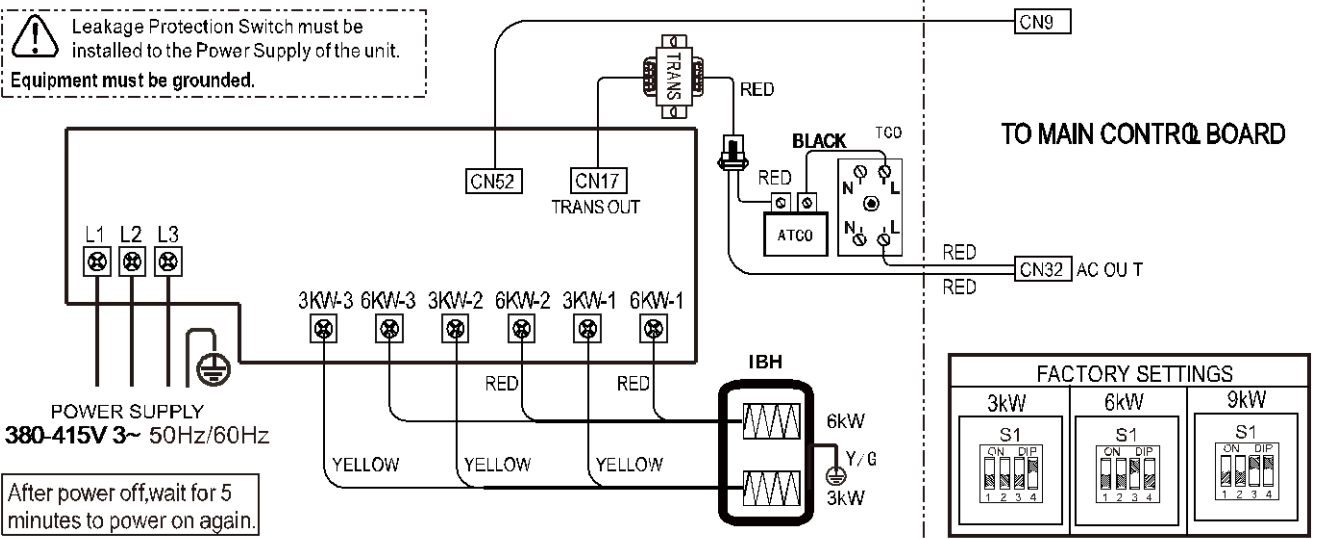

After power off, wait for 5 minutes to power on again.

3 Electric Control Box Layout

MUAMR-04-H14, MUAMR-06-H14

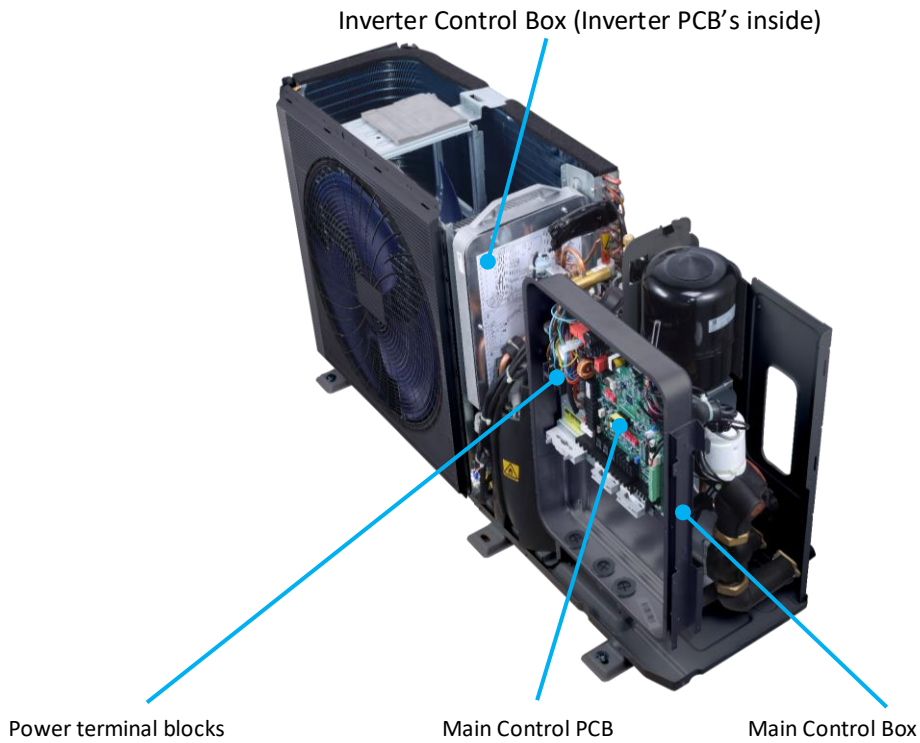

MUAMR-08-H14, MUAMR-10-H14

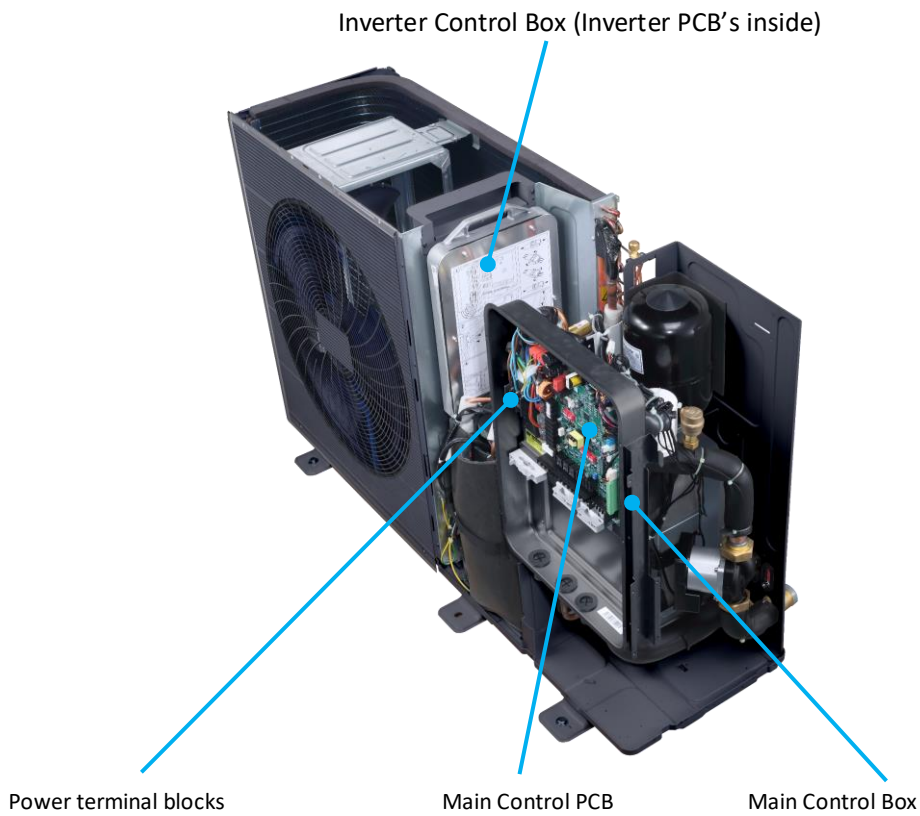

MUAMR-12-H14, MUAMR-14-H14, MUAMR-16-H14

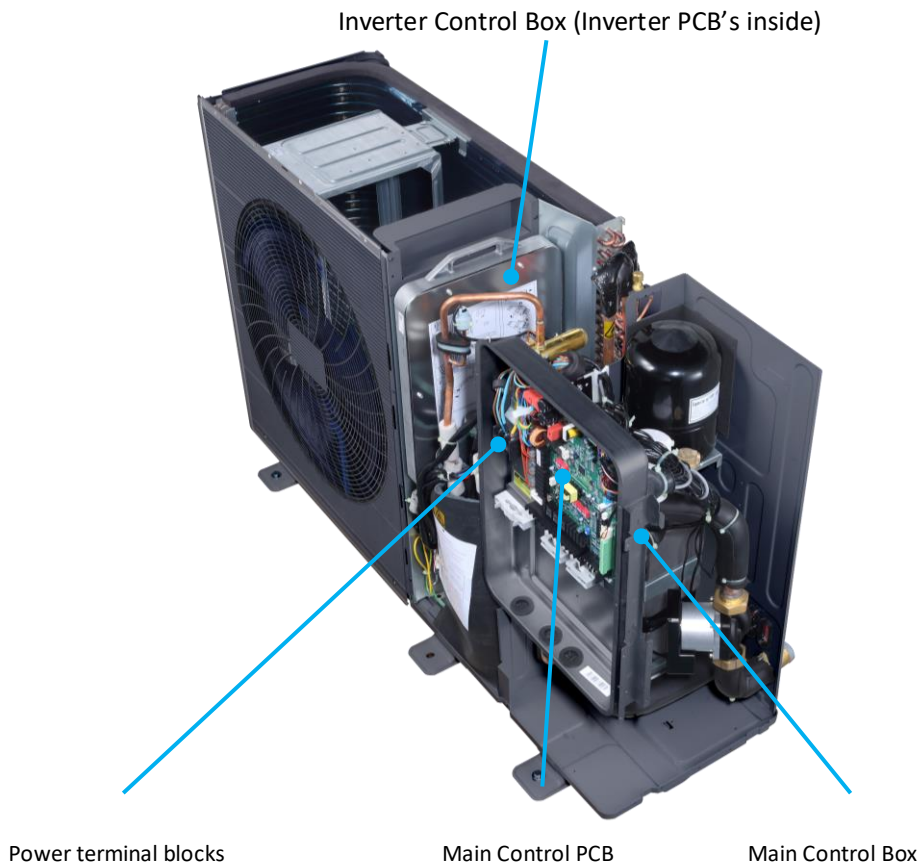

MUAMR-16-H14T, MUAMR-14-H14T, MUAMR-12-H14T

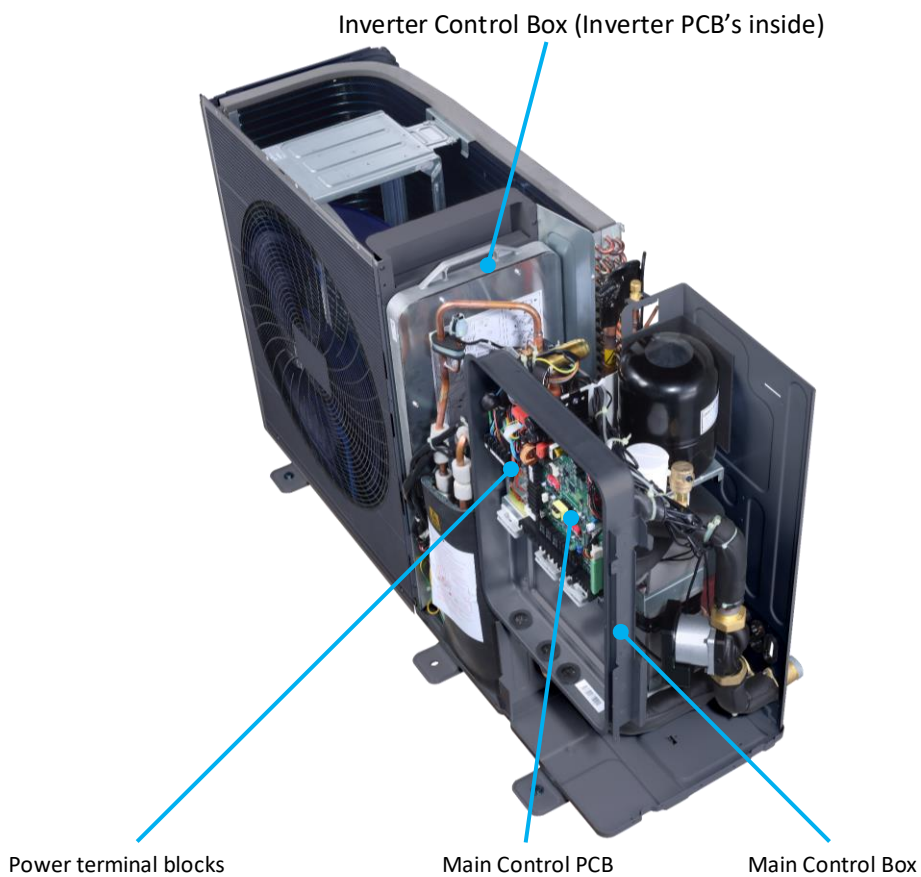

Note:

1. Main Control PCB consists of Refrigerant system and hydronic system, which is sealed in the hermetic electric control box and placed vertically for safety consideration.
2. The hermetic electric control box of inverter PCB is available to be taken out entirely. If there's something wrong with inverter PCB, it's suggested to unscrew the cover to identify whether inverter PCB failed (Refer to Appendix to part 4: Guide for identifying inverter PCB failure) and replace the whole inverter control box entirely.

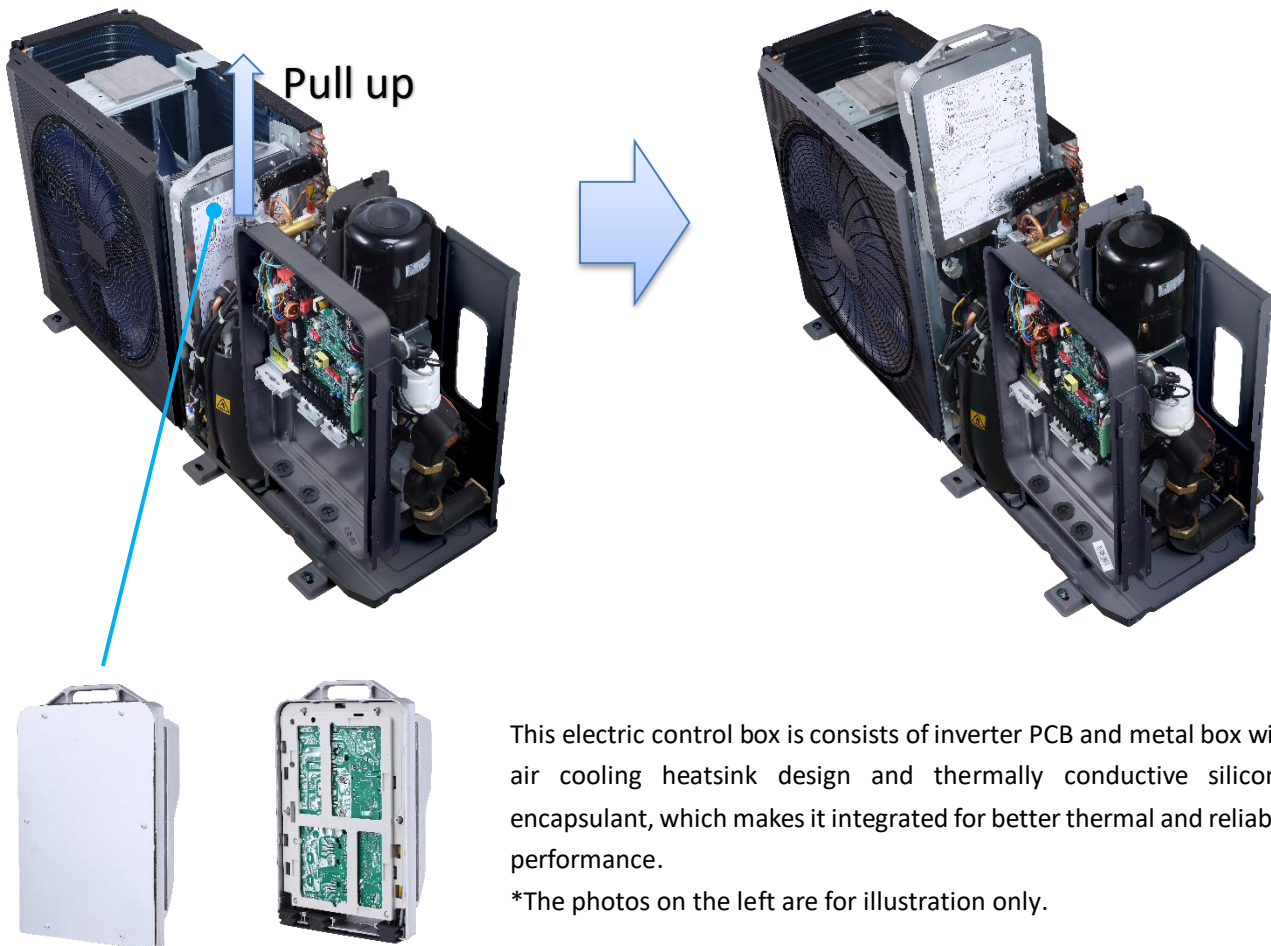

This electric control box consists of inverter PCB and metal box with air cooling heatsink design and thermally conductive silicone encapsulant, which makes it integrated for better thermal and reliable performance.

*The photos on the left are for illustration only.

4 Outdoor Unit PCBs

4.1 Main Control PCB

MUAMR-04-H14, MUAMR-06-H14, MUAMR-08-H14, MUAMR-10-H14, MUAMR-12-H14, MUAMR-14-H14, MUAMR-16-H14

Main Control PCB of 4-16kW

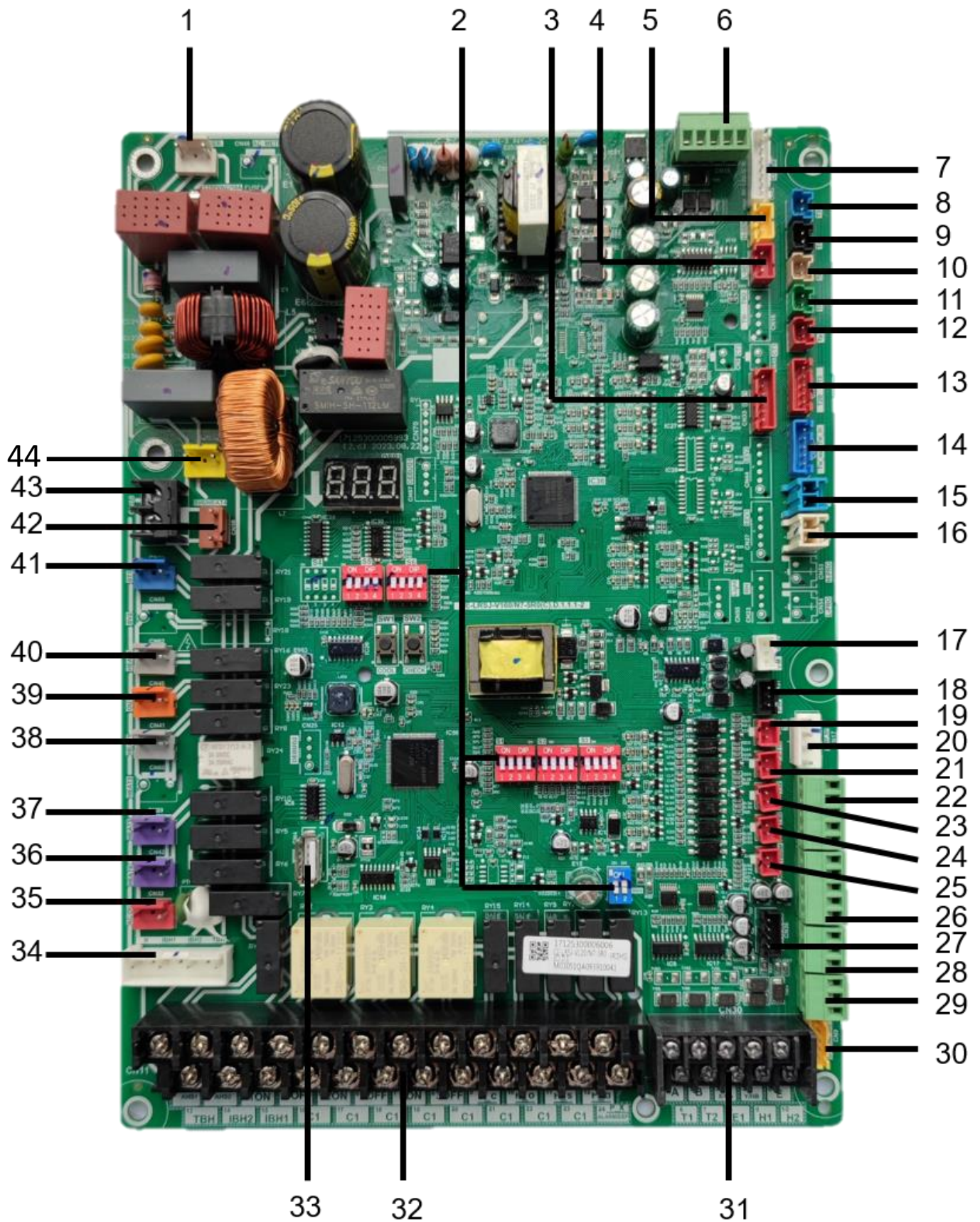

Label	Port	Code	Content	Rated Voltage
1	CN21	POWER	Port for power supply	230VAC
2	S1,S2,S3,S5 ,S6,SW9	/	Dip switch	0-5V DC
3	CN33	EEV1	Port for electrical expansion valve1	0-12V DC
4	CN3	H-SEN	Port for high pressure sensor	0-5V DC
5	CN46	L-SEN	Port for low pressure sensor	0-5V DC
6	CN35	RS485 ; on/off	Reserved	0-5V DC
7	CN43	COMM	Port for communication with Inverter PCB	0-5V DC
8	CN34	T3	Port for T3 temp.sensor	0-3.3V DC
9	CN45	T4	Port for T4 temp.sensor	0-3.3V DC
10	CN7	TL	Port for TL temp.sensor	0-3.3V DC
11	CN5	Th	Port for Th temp.sensor	0-3.3V DC
12	CN50	Tp	Port for Tp temp.sensor	0-3.3V DC
13	CN47	T2 T2B	Port for T2,T2B temp.sensor	0-5V DC
14	CN10	Tw_in ; Tw_out	Port for Tw_in,Tw_out temp.sensor	0-5V DC
15	CN39	T1	Port for T1 temp.sensor	0-5V DC
16	CN8	FS	Port for flow switch	0-12V DC
17	CN20	FM	Reserved	0-5V DC
18	CN37	PW	Port for temperature sensor of water pressure	0-5V DC
19	CN24	Tbt	Port for Tbt temp. sensor	0-5V DC
20	CN17	PUMP_BP	Port for internal pump	0-5V DC
21	CN13	T5/T1B	Port for T5/T1B temp. sensor	0-5V DC
22	CN66	K1 K2 S1 S2	Reserved	0-5V DC
23	CN38	T52	Port for T52 temp. sensor	0-5V DC
24	CN15	Tw2	Port for Tw2 temp. sensor	0-5V DC
25	CN18	Tsolar	Port for Tsolar temp. sensor	0-5V DC
26	CN31	0-10V ; HT ; COM ; CL	(0-10V) - Output port for 0-10V (HT) - Control port for room thermostat (heating mode) (COM) - Power port for room thermostat (CL) - Control port for room thermostat (cooling mode)	0-5V DC
27	CN36	+12V T1 T2 GND	Port for thermostat transfer board	0-12V DC
28	CN63	SG EVU	(SG) - Port for smart grid (photovoltaic signal) (EVU) - Port for smart grid (grid signal)	0-12V DC
29	CN61	M1 M2	Port for remote switch	0-12V DC
30	CN9	NOP GND IBH2 IBH1	Control port for internal backup heater1/2	0-5V DC
31	CN30	A B X/HA Y/HB E T1 T2 E1 H1 H2	(Port,3,4) - Port for communication with the User Interface (Port 6.7) - Port for thermostat transfer board (Port 8,9,10) - Port for Internal machine Parallel	AB:12VDC X/HA Y/HB:18VDC T1 T2 E1 H1 H2: 0-5VDC
32	CN11	/	(Port1,2) - Additional heat source (Port3,4) - Port for SV1(3-way valve) (Port5,6) - Port for SV2(3-way valve) (Port7,8) - Port for SV3(3-way valve)	230V AC

			(Port9,10,11,12) - Port for zone 2 pump(P_c)/ zone 1 pump(P_o)/ solar energy pump(P_s)/ pipe pump(P_d) (Port13) - Control port for tank booster heater (Port14) - Control port for internal backup heater 1 (Port15) - Control port for internal backup heater (Port24) - Reserved	
33	CN4	USB	Port for USB	
34	CN22	N IBH1 BH2 TBH	Control port for backup heater/booster heater	230V AC
35	CN32	AC OUT	Port for transformer power input	230V AC
36	CN42	HEAT6	Port for anti-freeze electric heating tape	230V AC
37	CN29	HEAT5	Port for anti-freeze electric heating tape	230V AC
38	CN41	HEAT2	Reserved	230V AC
39	CN40	OUT1	Reserved	230V AC
40	CN62	HEAT3	Port for electrical heating tape	230V AC
41	CN71	ST1	Port for 4-way valve	230V AC
42	CN56	/	Port for the heating tape of drainage outlet	230V AC
43	CN68	/	Port for the heating tape of drainage outlet	230V AC
44	CN28	PUMP	Port for inverter pump power input	

4.2 Inverter PCB

4-6kW Inverter PCB MUAMR-04-H14, MUAMR-06-H14

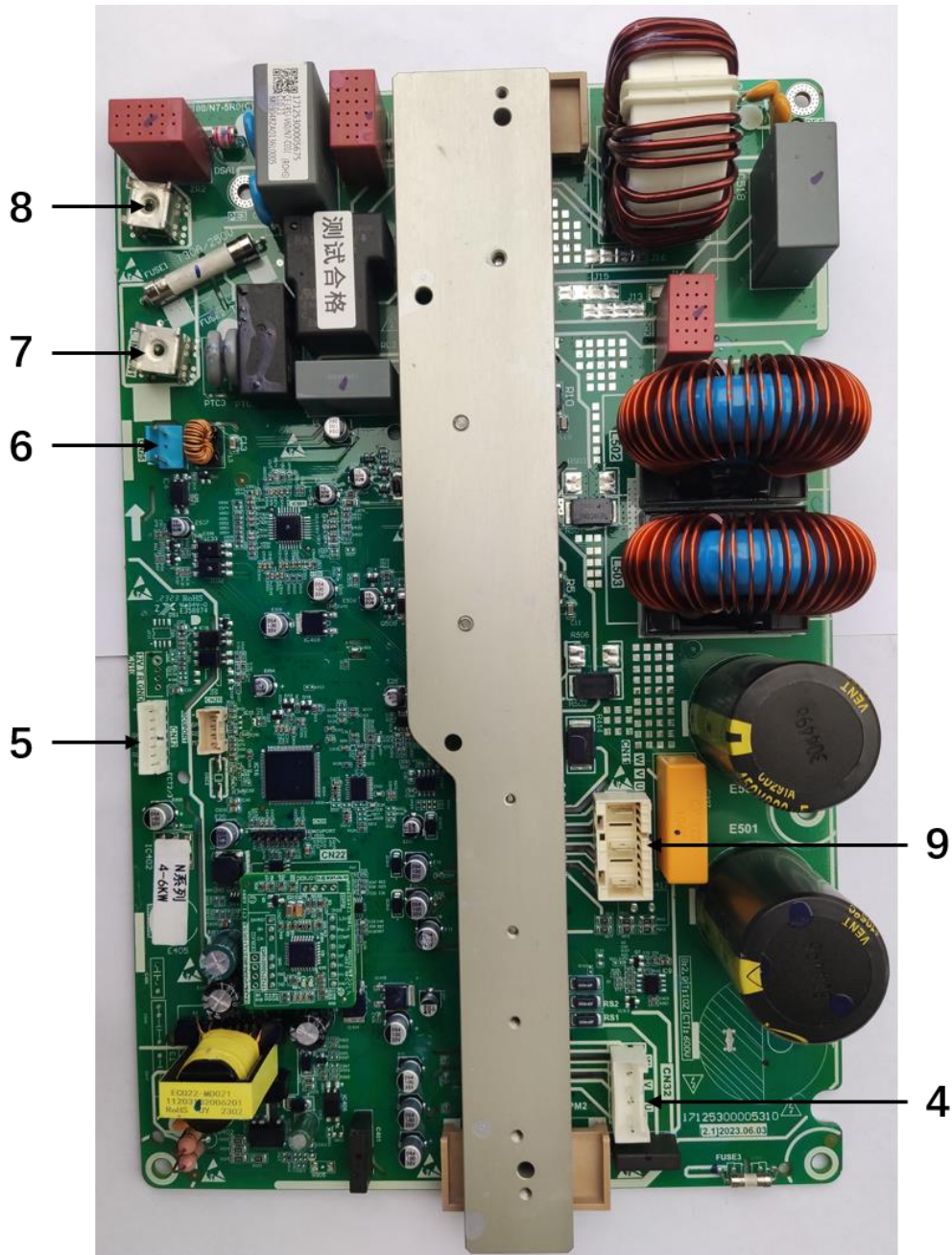

Label	Port	Code	Content	Voltage
4	CN32	/	DC fan power ports	Above 156V DC (varying according to frequency)
5	CN12	/	Port for communication with Main Control PCB	0-5V DC
6	CN25	H-pro	Connect to high pressure switch	0-5V DC
7	CN1	L_IN	Power input L of inverter PCB	230V AC
8	CN2	N_IN	Power input N of inverter PCB	230V AC
9	CN11	/	Power output of inverter PCB to compressor	Above 156V DC (varying according to frequency)

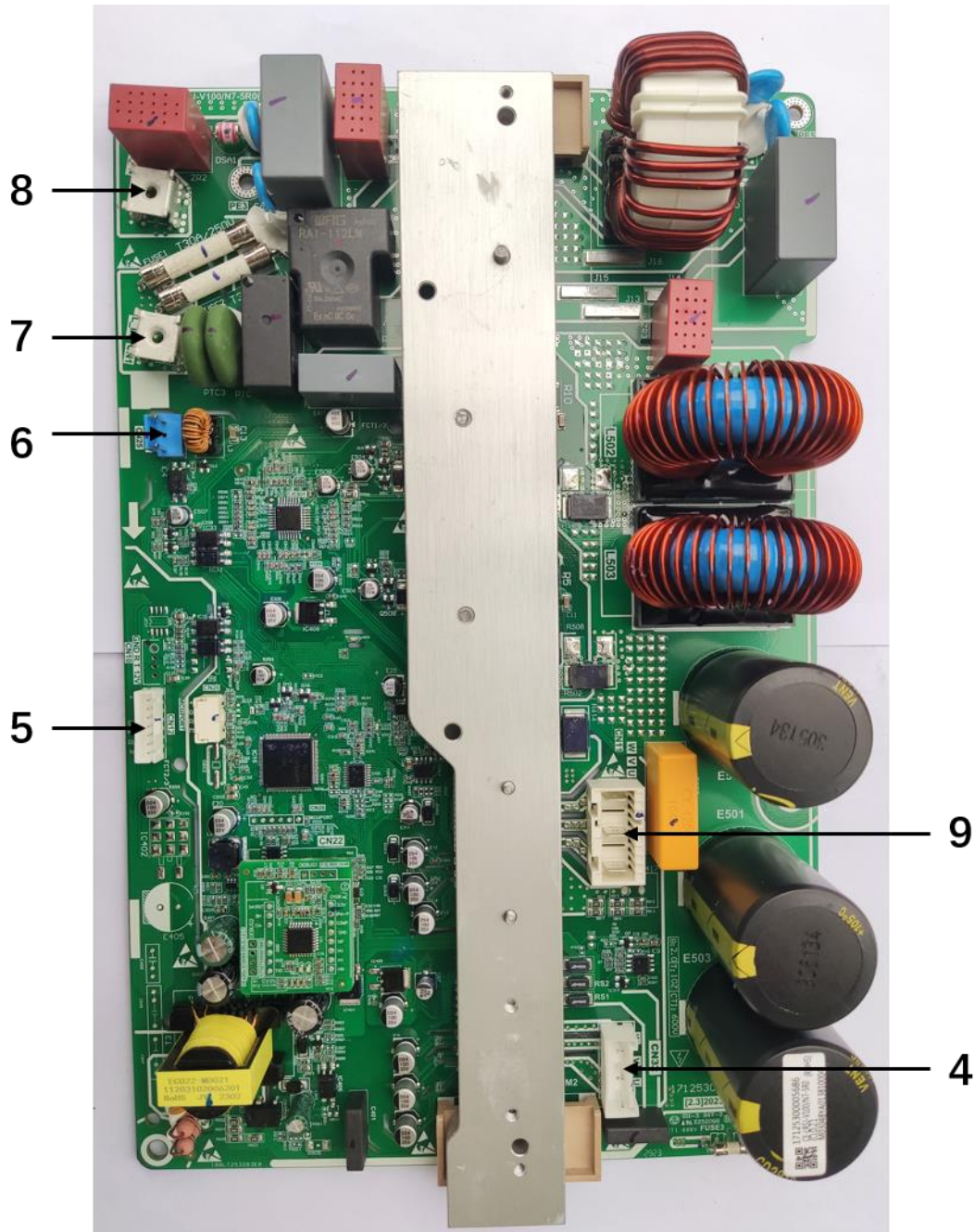

Label	Port	Code	Content	Voltage
4	CN32	/	DC fan power ports	Above 156V DC (varying according to frequency)
5	CN12	/	Port for communication with Main Control PCB	0-5V DC
6	CN25	H-pro	Connect to high pressure switch	0-5V DC
7	CN1	L_IN	Power input L of inverter PCB	230V AC
8	CN2	N_IN	Power input N of inverter PCB	230V AC
9	CN11	/	Power output of inverter PCB to compressor	Above 156V DC (varying according to frequency)

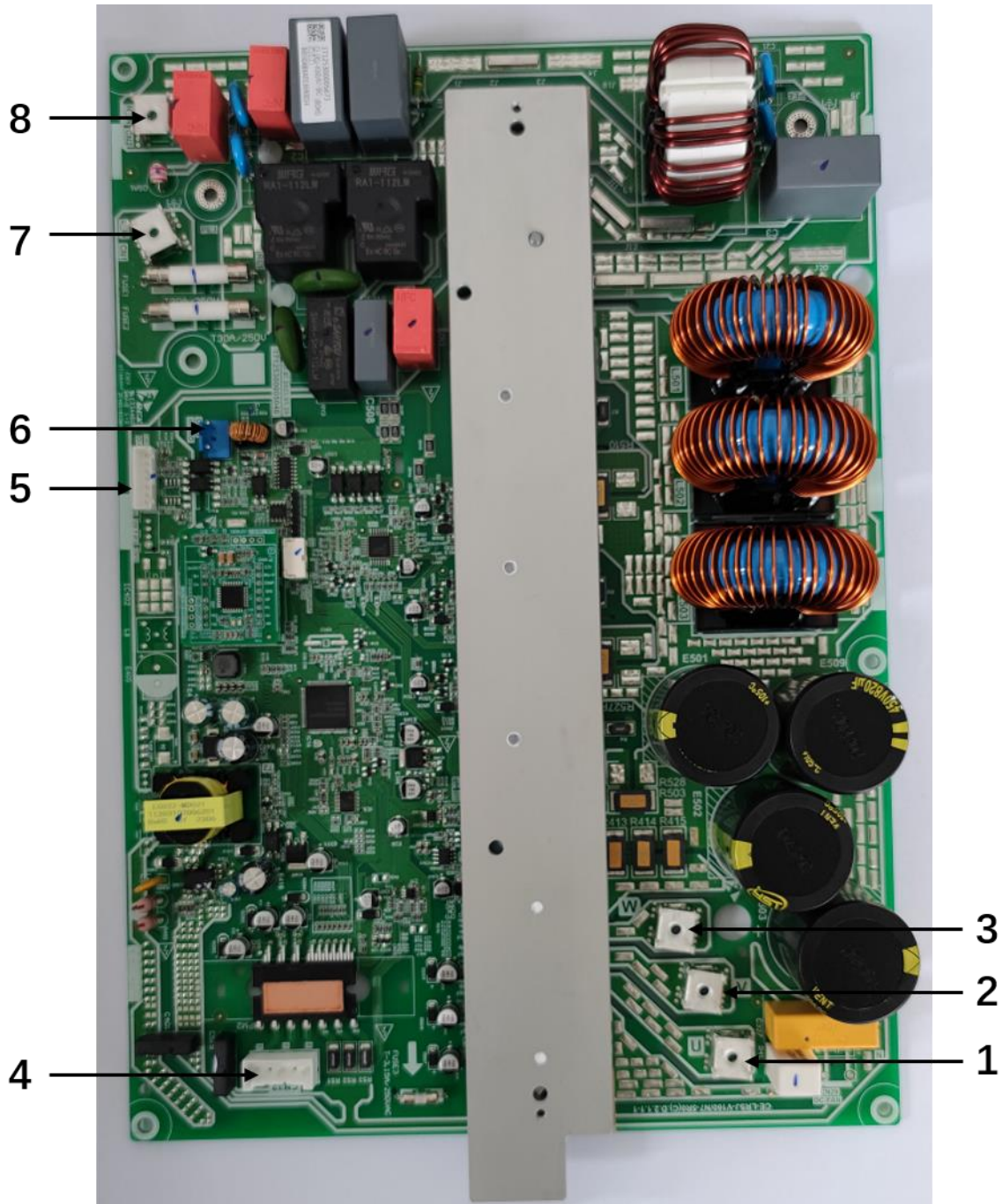

Label	Port	Code	Content	Voltage
1	U	U	Power output U of inverter PCB to compressor	Above 156V DC (varying according to frequency)
2	V	V	Power output V of inverter PCB to compressor	Above 156V DC (varying according to frequency)
3	W	W	Power output W of inverter PCB to compressor	Above 156V DC (varying according to frequency)
4	CN32	/	DC fan power ports	Above 156V DC (varying according to frequency)
5	CN12	/	Port for communication with Main Control PCB	0-5V DC
6	CN25	H-pro	Connect to high pressure switch	0-5V DC
7	CN1	L_IN	Power input L of inverter PCB	230V AC
8	CN2	N_IN	Power input N of inverter PCB	230V AC
9	CN11	/	Power output of inverter PCB to compressor	Above 156V DC (varying according to frequency)

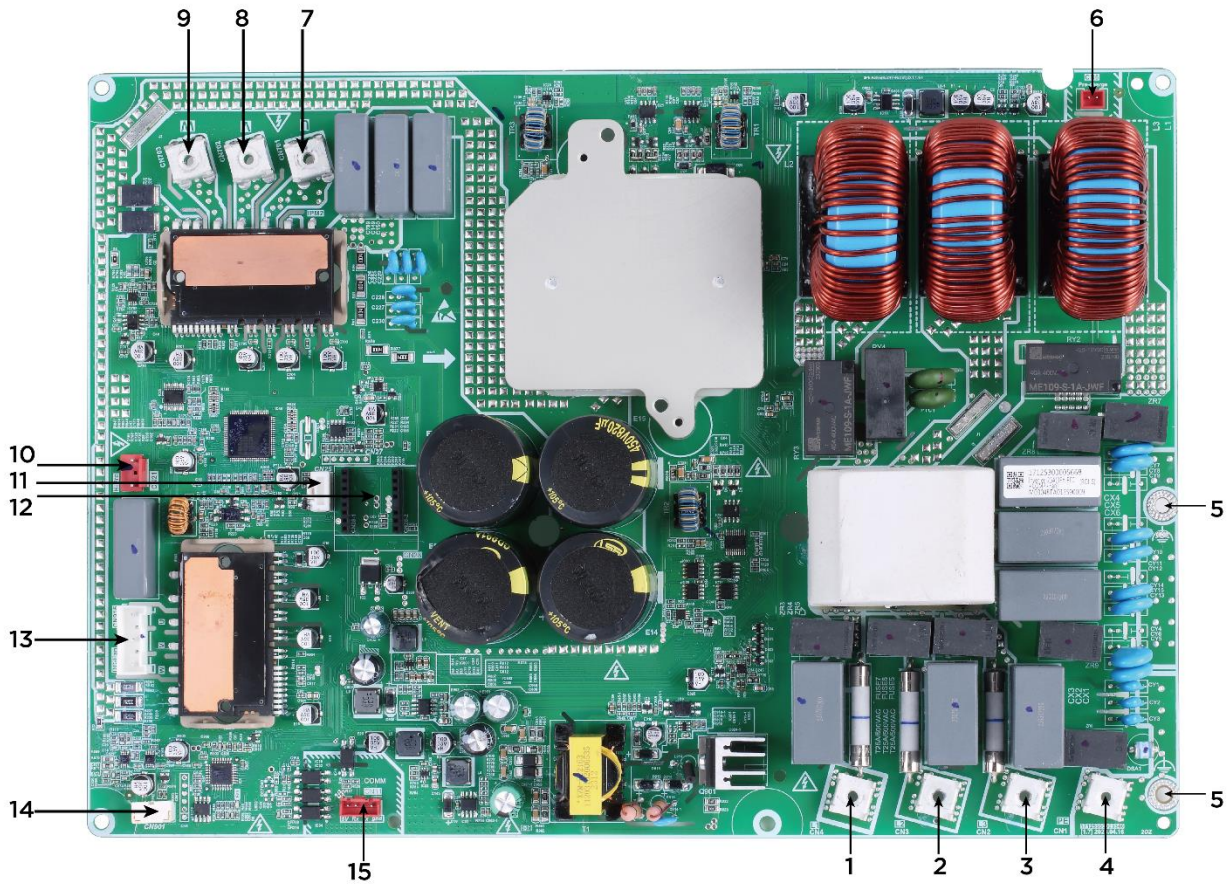

Label	Port	Code	Content	Voltage
1	CN4	L1	Power input L1 of inverter PCB	Phase to phase voltage 380VAC
2	CN3	L2	Power input L2 of inverter PCB	Phase to phase voltage 380VAC
3	CN2	L3	Power input L3 of inverter PCB	Phase to phase voltage 380VAC
4	CN1	PE	Ground	/
5	/	/	Ground	/
6	CN6	Pre-charge	Precharge for relay (low power) control port	12VDC;
7	CN701	U	Power output U of inverter PCB to compressor	Phase to phase voltage 46-460VAC
8	CN702	V	Power output V of inverter PCB to compressor	Phase to phase voltage 46-460VAC
9	CN703	W	Power output W of inverter PCB to compressor	Phase to phase voltage 46-460VAC
10	CN21	H-Pro	Connect to high pressure switch	On: 0V; Off: 6V;
11	CN25	Degug	/	/
12	CN28	PED	PED board	/
13	CN916	DCFAN	DC fan power ports	Phase to phase voltage 46-460VAC
14	CN901	Debug	/	/
15	CN11	COMM	Port for communication with Main Control PCB	0-5V DC

R290 MUAMR-H14 Series

3Ph 9kW IBH PCB MUAMR-16-H14T, MUAMR-14-H14T, MUAMR-12-H14T

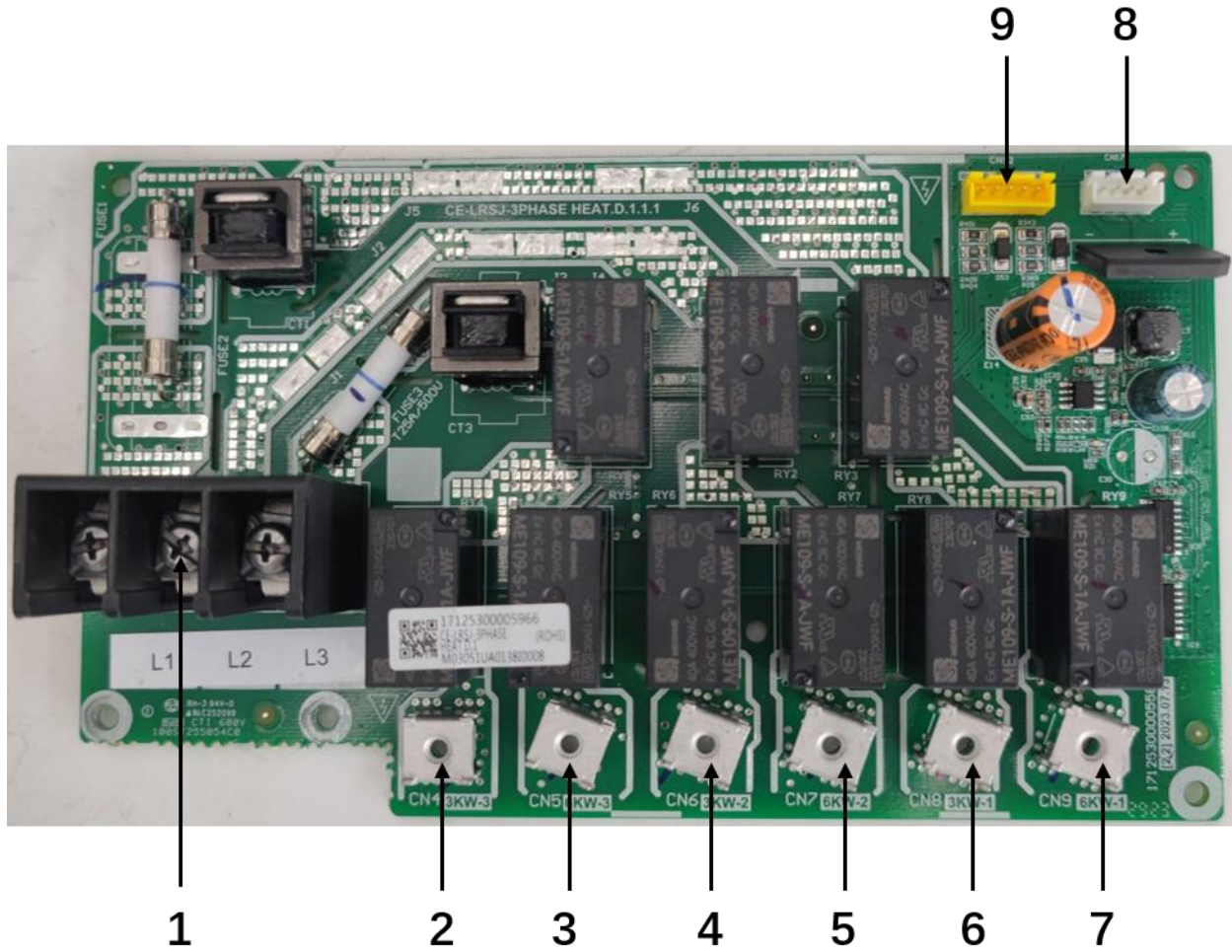

Label	Port	Code	Content	Voltage
1	CN22	L1 L2 L3	Power input L1/L2/L3 of IBH PCB	Phase to phase voltage 380VAC
2	CN4	3KW-3	Power input L3 of 3KW IBH	Phase to phase voltage 380VAC
3	CN5	6KW-3	Power input L3 of 6KW IBH	Phase to phase voltage 380VAC
4	CN6	3KW-2	Power input L2 of 3KW IBH	Phase to phase voltage 380VAC
5	CN7	6KW-2	Power input L2 of 6KW IBH	Phase to phase voltage 380VAC
6	CN8	3KW-1	Power input L1 of 3KW IBH	Phase to phase voltage 380VAC
7	CN9	6KW-1	Power input L1 of 6KW IBH	Phase to phase voltage 380VAC
8	CN17	TRANS OUT	Transformer outputs to IBH	13.5VAC
9	CN52	IBH1 IBH2 GND IA IB	Main board to IBH board control port	5VDC(varying);

4.4 Digital Display Output

Digital display output in different operating states

Outdoor unit state	Parameters displayed on Main Control PCB DSP1
On standby	0
Normal operation	The current frequency of compressor
Error or protection	Error or protection code



4.5 DIP Switch Settings

The DIP switch S3 on the Main Control PCB is used for setting the Modbus address. By defaulting the units have this DIP switch positioned=0/0/0

Dip switch



S3	1/2/3	0/0/0=address 0#(master units)	1:OFF 2:OFF 3:OFF
		1/0/0=address 1#(slave units)	
		0/1/0=address 2#(slave units)	
		0/0/1=address 3#(slave units)	
		1/1/0=address 4#(slave units)	
		1/0/1=address 5#(slave units)	
		0/1/1=address 6#(slave units)	
4	Reserved	4:OFF	

(ON=1, OFF=0)

Modbus Connection

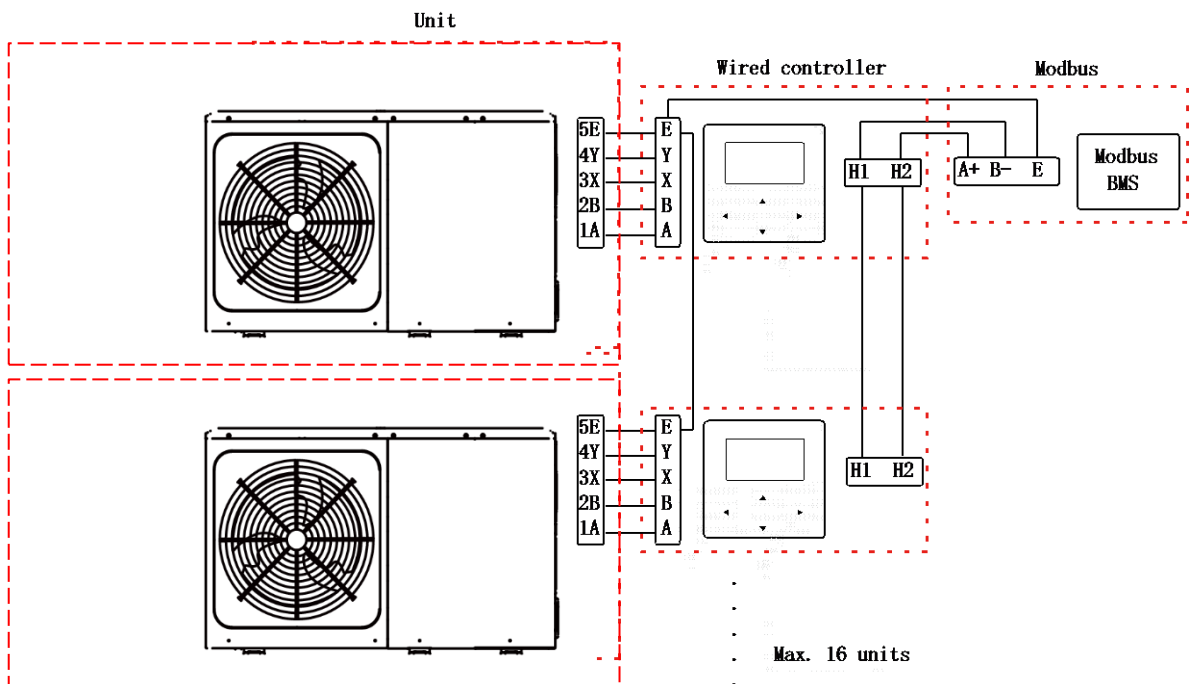

Modbus Wiring

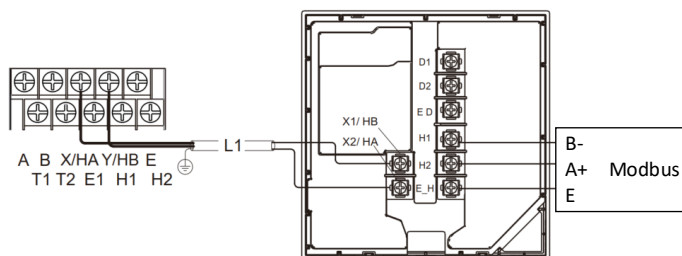

5 Error Code Table

Water circuit error			
Error code	Description	Displayed on	
E0	water flow failure (10 times of E8)	User Interface and Main Control PCB	
E8	water flow protection	User Interface and Main Control PCB	
Communication error			
Error code	Description	Displayed on	
E2	Communication fault between User Interface and Main Control PCB	User Interface and Main Control PCB	
H0	Communication error of Main Control PCB	User Interface and Main Control PCB	
H1	Communication error between Main Control PCB and inverter PCB	User Interface and Main Control PCB	
Hd	Communication fault between master unit and slave unit.	User Interface and Main Control PCB	
Sensor error			
Error code	Description	Displayed on	
E3	T1 Electric Heater/AHS water outlet temperature sensor error	User Interface and Main Control PCB	
E4	T5 Water tank temperature sensor error	User Interface and Main Control PCB	
E5	T3 Outdoor unit heat exchanger bottom temperature sensor error	User Interface and Main Control PCB	
E6	T4 Ambient temperature sensor error	User Interface and Main Control PCB	
E7	Tbt Balance tank temperature sensor/ Final outlet water temperature of cascade system sensor error	User Interface and Main Control PCB	
E9	Th Return-air temperature sensor error	User Interface and Main Control PCB	
EA	Tp Discharge temperature sensor error	User Interface and Main Control PCB	
Eb	Tsolar Solar panel temperature sensor error	User Interface and Main Control PCB	
EC	T5_2 Water tank temperature sensor error (Reserved)	User Interface and Main Control PCB	
Ed	Tw_in Plate heat exchanger inlet water temperature sensor error	User Interface and Main Control PCB	
FC1	TL Outdoor unit heat exchanger outlet temperature sensor error	User Interface and Main Control PCB	
H2	T2 Plate heat exchanger outlet refrigerant temperature sensor error	User Interface and Main Control PCB	
H3	T2B Plate heat exchanger inlet refrigerant temperature sensor error	User Interface and Main Control PCB	
H5	Ta room temperature sensor error	User Interface and Main Control PCB	
H8	H-SEN High pressure sensor error	User Interface and Main Control PCB	
H9	Tw2 Zone 2 water flow temperature sensor error	User Interface and Main Control PCB	
HA	Tw_out Plate heat exchanger outlet water temperature sensor error	User Interface and Main Control PCB	
P21	L-SEN Low pressure sensor error	User Interface and Main Control PCB	
P27	H-SEN and L-SEN connected reversely (Detect when compressor is off)	User Interface and Main Control PCB	

Voltage error			
Error code	Description	Displayed on	
E1	Phase loss or phase reversal	User Interface and Main Control PCB	For 3Ph models
H7	Power overvoltage and Power undervoltage protection	User Interface and Main Control PCB	
Protection code			
Error code	Description	Displayed on	
P0	Low pressure protection	User Interface and Main Control PCB	
P1	High pressure switch protection	User Interface and Main Control PCB	
P3	Overcurrent protection	User Interface and Main Control PCB	
P4	The protection for overhigh discharge temperature of Compressor	User Interface and Main Control PCB	
Pd	The protection for overhigh condensing temperature	User Interface and Main Control PCB	
HP	Low pressure protection in cooling mode	User Interface and Main Control PCB	
bA	T4 sensor out of operation range protection	User Interface and Main Control PCB	
PP	The protection for abnormal temperature difference between outlet water and inlet water	User Interface and Main Control PCB	
Hb	3 times of PP and Twout<7°C	User Interface and Main Control PCB	
P5	The big temperature difference between outlet water temp. and inlet water temp.	User Interface and Main Control PCB	
Inverter module error/ protection			
Error code	Description	Displayed on	
F1	The protection for undervoltage of DC bus	User Interface and Main Control PCB	
C7	Overhigh temperature protection for IPM module	User Interface and Main Control PCB	
H4	3 times of "L1*" in 60 mins	User Interface and Main Control PCB	
L1E	Hardware overcurrent protection	Main Control PCB	
L11	Phase current instantaneous overcurrent protection	Main Control PCB	
L12	Phase current continuous 30s overcurrent protection	Main Control PCB	
L2E	Over-temperature protection	Main Control PCB	
L3E	Bus voltage too low error	Main Control PCB	
L31	Bus voltage too high error	Main Control PCB	
L32	Bus voltage excessively high error	Main Control PCB	
L34	Phase loss error of three-phase power supply	Main Control PCB	For 3Ph models
L43	Abnormal phase current sampling bias	Main Control PCB	
L45	Fan motor code mismatch error	Main Control PCB	
L46	IPM protection (FO)	Main Control PCB	
L47	Module type mismatch	Main Control PCB	
L5E	Motor failed to start	Main Control PCB	
L52	Motor stalling protection	Main Control PCB	
L6E	Phase loss protection	Main Control PCB	
L61	compressor terminals short circuit protection	Main Control PCB	
L65	IPM short circuit protection	Main Control PCB	
LBE	Action of high pressure switch	Main Control PCB	
LB7	PED bH error	Main Control PCB	
LCE	PFC hardware overcurrent protection	Main Control PCB	For 3Ph models
LC1	Instantaneous overcurrent of pfc software protection	Main Control PCB	For 3Ph models
LC2	PFC software continuous 30 s overcurrent protection	Main Control PCB	For 3Ph models

LC3	PFC low voltage protection	Main Control PCB	For 3Ph models
LC4	PFC power factor is less than 0.8	Main Control PCB	For 3Ph models
LC5	PFC valid value overcurrent protection	Main Control PCB	For 3Ph models
LC6	PFC1 channel hardware overcurrent protection	Main Control PCB	For 3Ph models
LC7	PFC2 channel hardware overcurrent protection	Main Control PCB	For 3Ph models
LC8	PFC3 channel hardware overcurrent protection	Main Control PCB	For 3Ph models
LC9	Over-temperature protection of PFC module	Main Control PCB	For 3Ph models
LCA	PFC module CBC overcurrent error protection	Main Control PCB	For 3Ph models
LCB	Overvoltage of PFC bus or PFC half bus	Main Control PCB	For 3Ph models
LCC	Short circuit of PFC IGBT	Main Control PCB	For 3Ph models
LCD	Abnormal PFC Ad sampling bias	Main Control PCB	For 3Ph models
H6	Fan failure	User Interface and Main Control PCB	
HH	10 times of H6 in 120mins	User Interface and Main Control PCB	
J1E	Hardware overcurrent protection	Main Control PCB	
J11	Phase current instantaneous overcurrent protection	Main Control PCB	
J12	Phase current continuous 30s overcurrent protection	Main Control PCB	
J2E	Over-temperature protection	Main Control PCB	
J3E	Bus voltage too low error	Main Control PCB	
J31	Bus voltage too high error	Main Control PCB	
J32	Bus voltage excessively high error	Main Control PCB	
J43	Abnormal phase current sampling bias	Main Control PCB	
J45	Fan motor code mismatch error	Main Control PCB	
J46	IPM PROTECTION (FO)	Main Control PCB	
J47	Module type mismatch (after module resistance tested)	Main Control PCB	
J5E	Motor failed to start	Main Control PCB	
J52	Motor stalling protection	Main Control PCB	
J6E	Phase loss protection	Main Control PCB	
J61	Fan terminals short circuit protection	Main Control PCB	
J65	IPM short circuit protection	Main Control PCB	
HF	Outdoor unit EEPROM error	User Interface and Main Control PCB	
Others			
Error code	Description	Displayed on	
Pb	Pb is the indicator that shows the system is running in anti-freezing control	Main Control PCB	
IBH-related error			
Error code	Description	Displayed on	
C2	Relay adhesion on IBH PCB	User Interface and Main Control PCB	For Units with IBH
C3	Current transformer failure or circuit failure of IBH PCB	User Interface and Main Control PCB	For Units with IBH
C4	C3 ≥ 3 times	User Interface and Main Control PCB	For Units with IBH

6 Troubleshooting

6.1 Warning

WARNING!

- All electrical work must be carried out by competent and suitably qualified, certified and accredited professionals and in accordance with all applicable legislation (all national, local and other laws, standards, codes, rules, regulations and other legislation that apply in a given situation).
- Power-off the outdoor units before connecting or disconnecting any connections or wiring, otherwise electric shock (which can cause physical injury or death) may occur or damage to components may occur.

6.2 E0, E8 Troubleshooting

6.2.1 Digital display output

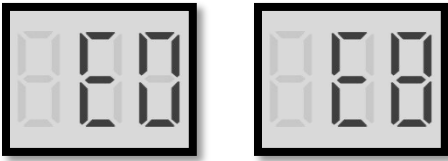

6.2.2 Description

Error code		E0	E8
Description		water flow failure	water flow protection
Triggering		5 times of No-water detection failures in a row before pump on Or 10 times of E8 in a row when do running-water detection after pump on	No-water detection failures within 5 times before pump on Or Water flow switch breaks 10 times in a row when do running-water detection after pump on
Relative ports and locations	CN28 PUMP (To supply power for water pump)		
	CN17 PUMP BP (feedback signal of water pump)		
	CN8 FS (signal of water flow switch)		

Layout of main component

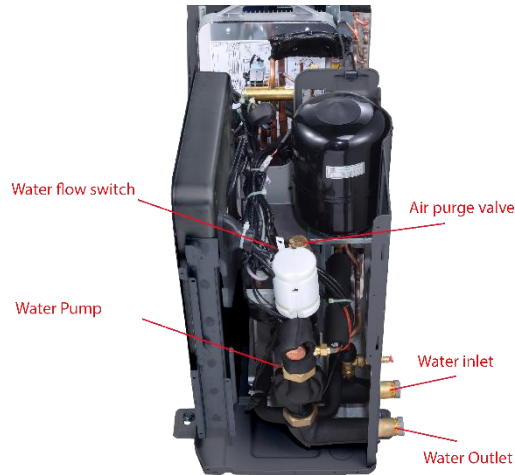

User Interface

E0(**%) /E8(**%) is displayed on the User Interface. The percentage indicates possible cause of water flow failure, which is illustrated as note 1.

Error info.			
Unit	Code	Time	Date
#00	E8(70%)	11:27	19-12-2022
#02	E0(50%)	15:30	19-12-2022
#01	E2	10:30	02-12-2022
#00	E8(70%)	11:27	25-10-2022

Correct Dip switch



S2	1/2	Reserved	1:OFF 2:OFF
	3/4	0/0=Variable speed pump (9m head) 0/1=Variable speed pump (8.5m head) 1/0=Fixed speed pump 1/1=Reserved	3:OFF 4:OFF



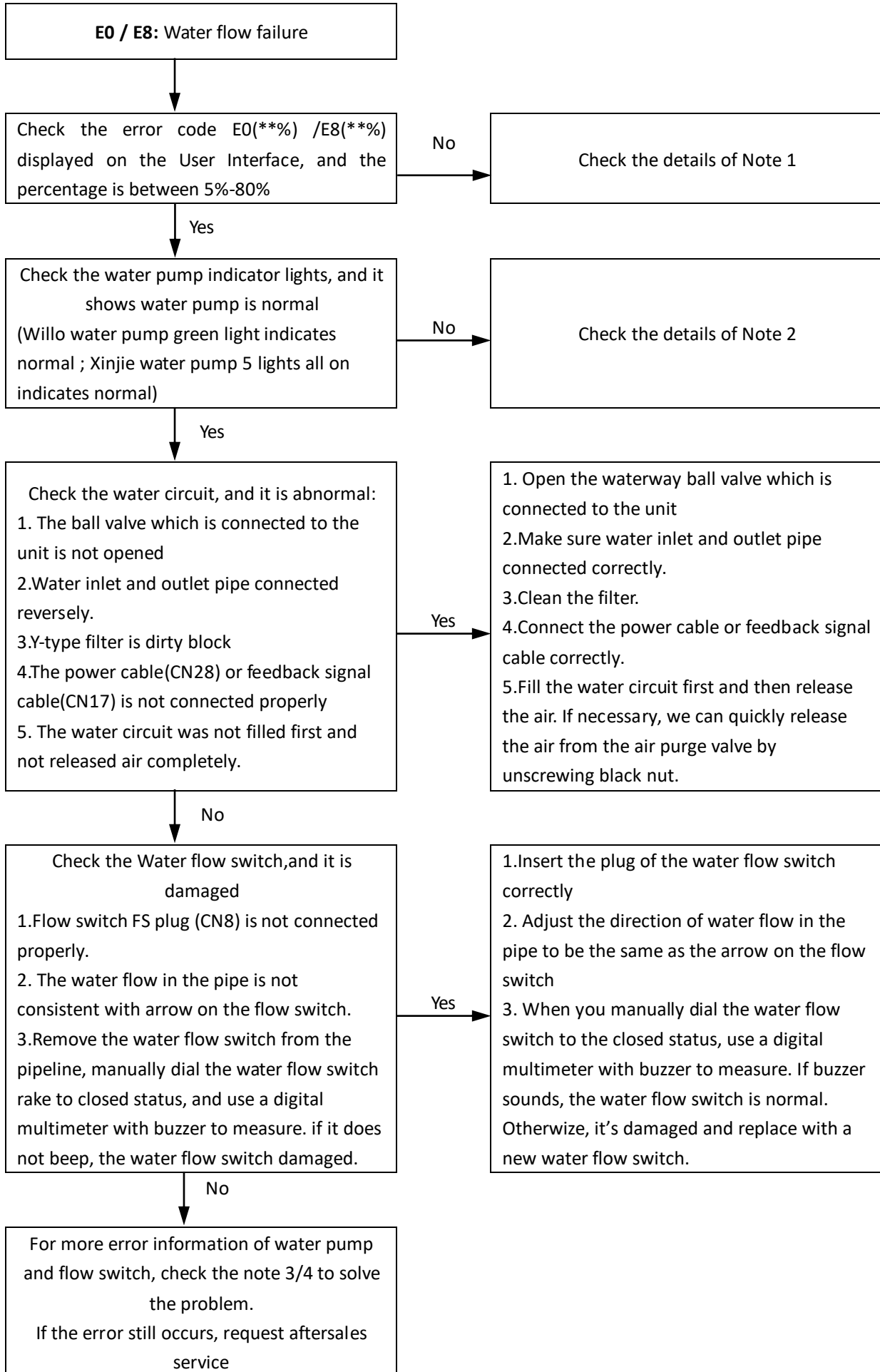

6.2.3 Procedure



Note 1 :

The meaning of percentage of water pump output(displayed on the user interface)			
Percentage	Water pump model	Brand	Description
0%	Para 25/9 IPWM-130-1	WILO	IPWM connection port short circuited
	APM25-9-130/180	SHIMGE	PWM feedback signal loss
2%	Para 25/9 IPWM-130-1	WILO	Pump Standby
	APM25-9-130/180	SHIMGE	Pump Standby
	APM25-9-130/180	SHIMGE	Pump Standby
80%	Para 25/9 IPWM-130-1	WILO	Undervoltage < 160/170-194V, and Pump keeps running
	APM25-9-130/180	SHIMGE	Alarm, and Pump keeps running (Low voltage: 170-194V; High voltage: 250-270V)
85%	Para 25/9 IPWM-130-1	WILO	Undervoltage < 160/170V; Overvoltage > 253V-264V; Motor overload; module overheat; external pump flow rate larger than internal pump flow rate, Pump stops running
	APM25-9-130/180	SHIMGE	Alarm, and pump stops running (Low voltage: <170V/ High voltage: >270V)
90%	Para 25/9 IPWM-130-1	WILO	Motor overspeed; over current; underspeed; pump stalling, and pump stops running
	APM25-9-130/180	SHIMGE	Alarm (Pump idling , pump stalling) and pump stops running
95%	Para 25/9 IPWM-130-1	WILO	Pump damaged; circuit damaged; terminal damaged, and pump stops running
	APM25-9-130/180	SHIMGE	Alarm; Phase loss; Overcurrent error, and pump stops running
100%	Para 25/9 IPWM-130-1	WILO	IPWM connection port open circuited
	APM25-9-130/180	SHIMGE	No PWM signal input

Note 2 – Indicator lights on Xinjie water pump :

Indicator lights on Xinjie water pump		
Name	Indicator lights	Description
motor stalling protection		When motor stalling happens, the pump tries to reboot every 5s, and indicator lights shows the error. After 5 times reboot, pump stops running
Overcurrent/ Undercurrent protection		When low voltage: <165V/ high voltage: >275V, pump stops running and indicator lights shows the error. When the voltage is back to 160V-270V, pump resume running
Phase loss protection		When phase loss happens, the pump tries to reboot every 1s, and indicator lights shows the error. After 5 times reboot, pump stops running
Overcurrent (Short circuit) protection		When overcurrent / overheat happens, the pump tries to reboot every 1s, and indicator lights shows the error. After 5 times reboot, pump stops running
Overheat protection		When power module overheat, pump stops running and indicator lights shows the error.

Note 3: The possible error and solutions of water pump

The possible causes of water pump failure and solutions		
Description	Possible cause	Solution
Error occurs at the first time running	Water pump leak	Replace the sealing ring
	Water inlet and outlet pipe connected reversely.	Connect the pipe correctly.
	The power cable (CN28) is not connected properly	Connect the power cable correctly.
	The feedback signal cable (CN17) is not connected properly	Connect the feedback signal cable correctly.
	The dip switch is not correct.	Correct the dip switch as the illustration above
Error occurs at the first time running or after running for a while	Pump idling	Fill the water circuit first and then release the air
	Pump stalling	Remove the water pump, Rotate the impeller manually until it can move freely. And then install it back. (If it's too hard to rotate the impeller manually, replace the water pump)
	Power supply is abnormal	Check the power supply
Error occurs after running for a while	E8 occurs after water pump running for a while	Fill the water circuit first and then release the air.
Error occurs at the first time running or after running for a while	Motor stall, and it can not be rotated manually	Replace water pump
Error occurs at the first time running	Water pump connection is correct, the water pump icon on the User Interface is lit, while no indicator lights on water pump is lit.	Replace water pump

Note 4: The possible error and solutions of water flow switch failure

The possible causes of water flow switch failure and solutions		
Description	Possible cause	Solution
Error occurs at the first time running	The water flow in the pipe is not consistent with arrow on the flow switch.	Adjust the direction of water flow in the pipe to be the same as the arrow on the flow switch
	Flow switch FS plug (CN8) is not connected properly.	Insert the plug of the water flow switch correctly
	External pump starts before internal pump (PUMPI) starts	Start internal pump first, make sure water flow is sufficient for external pump
Error occurs at the first time running or after running for a while	Flow switch not installed properly	Reinstall the flow switch correctly
	Flow switch leak	Replace the sealing ring
	flow switch rake blocked	Clean the obstacles
	flow switch rake damaged	Replace the flow switch
	The flow switch contact can not be completely closed	Replace the flow switch
	The flow switch contact can not be completely open	Replace the flow switch
	The flow switch model did not match	Replace the flow switch

6.3 E2 Troubleshooting

6.3.1 Digital display output

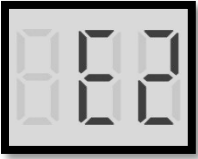

6.3.2 Description

Error code		E2
Description		Communication fault between User Interface and Main Control PCB
Triggering		Main Control PCB side: Communication failure with User Interface lasts 2 mins Or User Interface side: No communication reply from Main Control PCB for 1 min
Relative ports and locations	X/HA、Y/HB	

6.3.3 Procedure

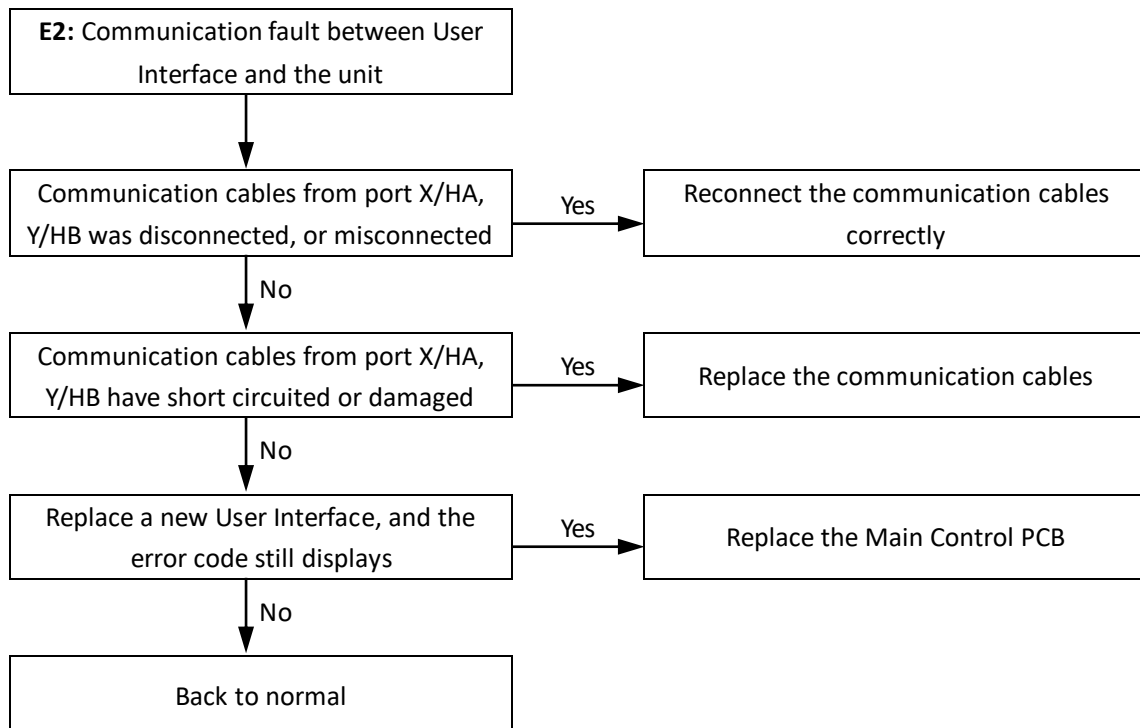

6.4 H0 Troubleshooting

6.4.1 Digital display output



6.4.2 Description

Error code	H0
Description	Communication error of Main Control PCB
Triggering	Communication failure lasts 1 min

6.4.3 Procedure

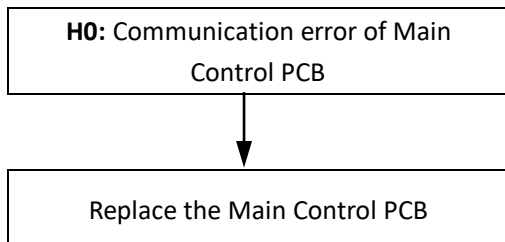

6.5 H1 Troubleshooting

6.5.1 Digital display output



6.5.2 Description

Error code		H1
Description		Communication error between Main Control PCB and inverter PCB
Triggering		Communication failure lasts 1 min
Relative ports and locations	CN43 COMM (Main Control PCB)	
	LED2 & BUS voltage(P-N) (1 Ph Inverter PCB)	
	LED2 & BUS voltage(P-N) (3 Ph inverter PCB)	<p>You can see the slim light of LED2 through the gap at the back of inverter PCB</p>

6.5.3 Procedure

For 1Ph models

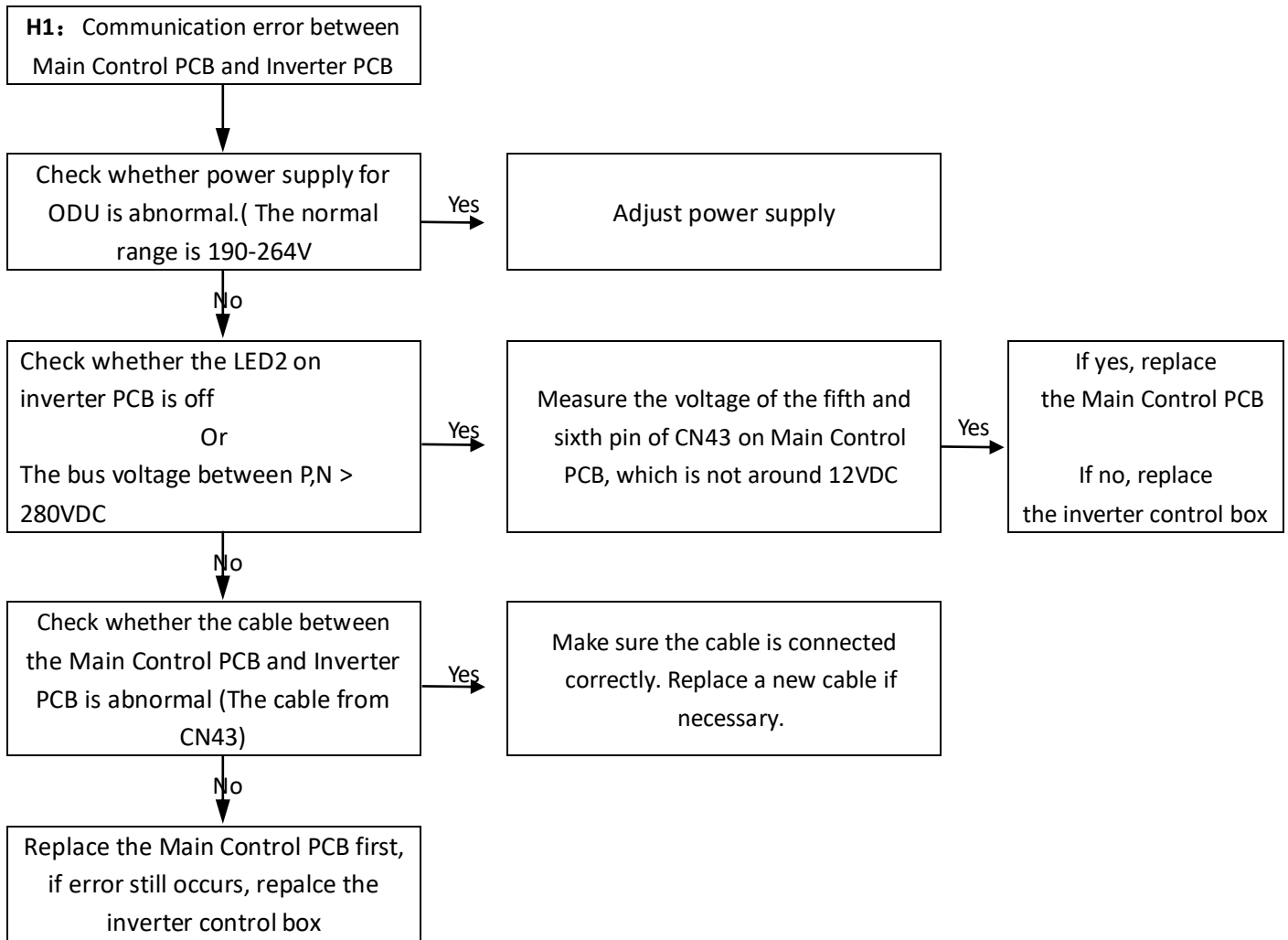

For 3Ph models

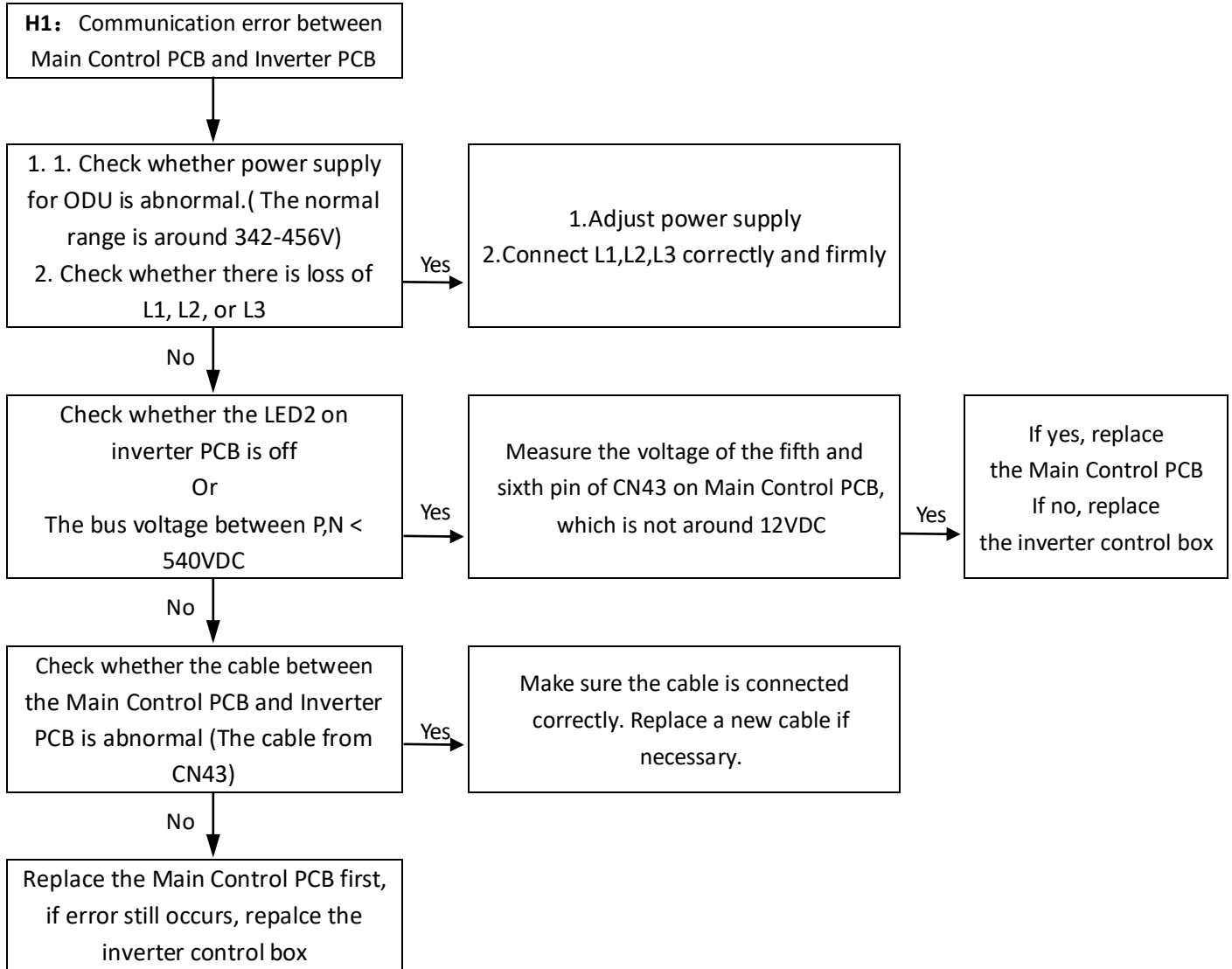

6.6 Hd Troubleshooting

6.6.1 Digital display output

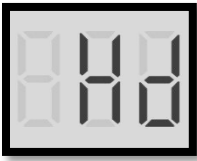

6.6.2 Description

Error code		Hd
Description		Communication fault between master unit and slave unit.
Triggering		For cascade system, the communication failure between master unit and slave unit lasts 2mins and above
Relative ports and locations	Communication port E1/H1/H2	
	Dip switch S3-1/2/3 0/0/0=address 0# (Master) 1/0/0=address 1# (Slave) 0/1/0=address 2# (Slave) 0/0/1=address 3# (Slave) 1/1/0=address 4# (Slave) 1/0/1=address 5# (Slave) 0/1/1=address 6# (Slave) 1/1/1=address 7# (Slave)	
	SW9 1/1=master unit 0/0=slave unit	

6.6.3 Procedure

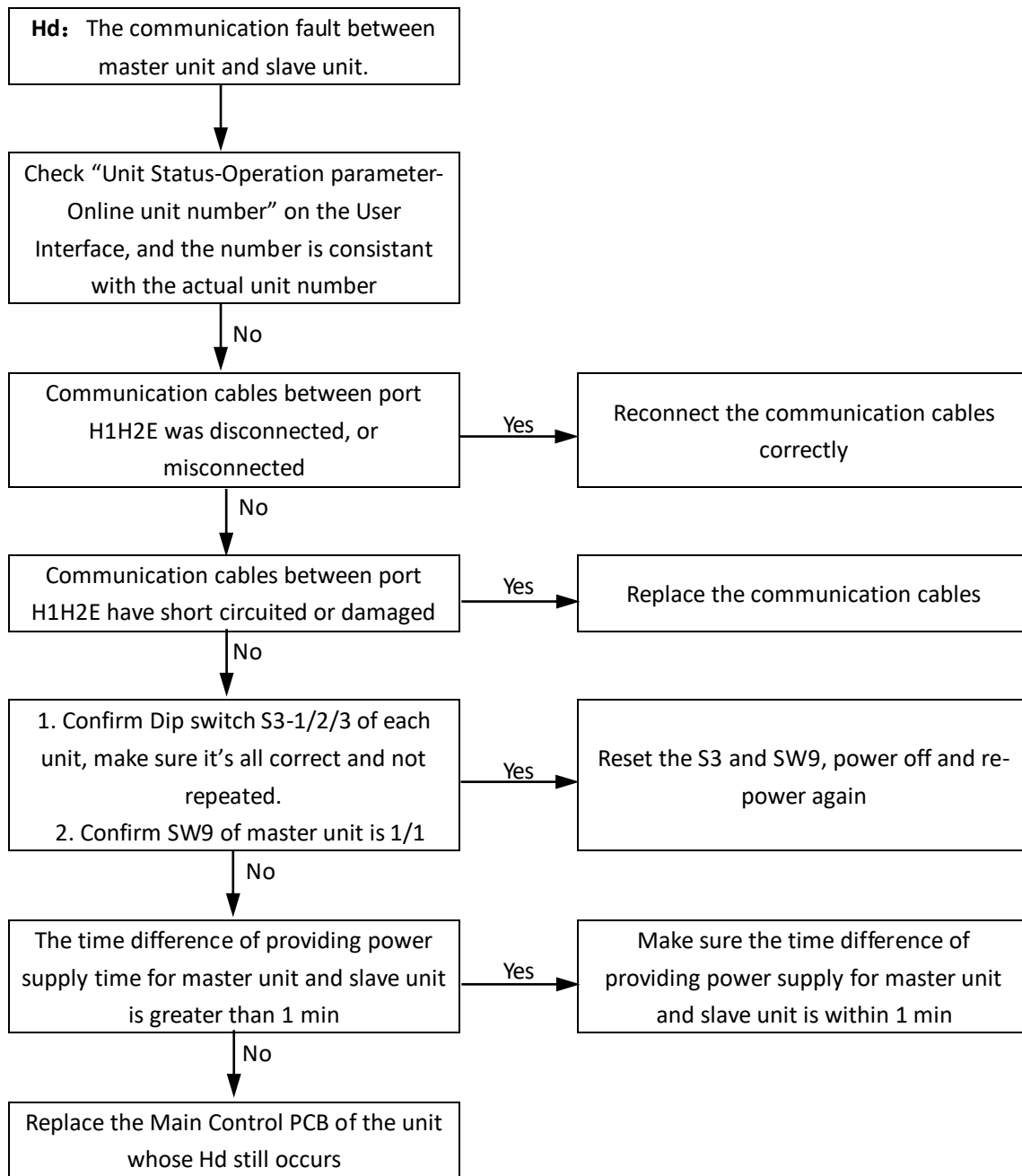

6.7 E5, E6, E9, EA, FC1, H2, H3 Troubleshooting

6.7.1 Digital display output

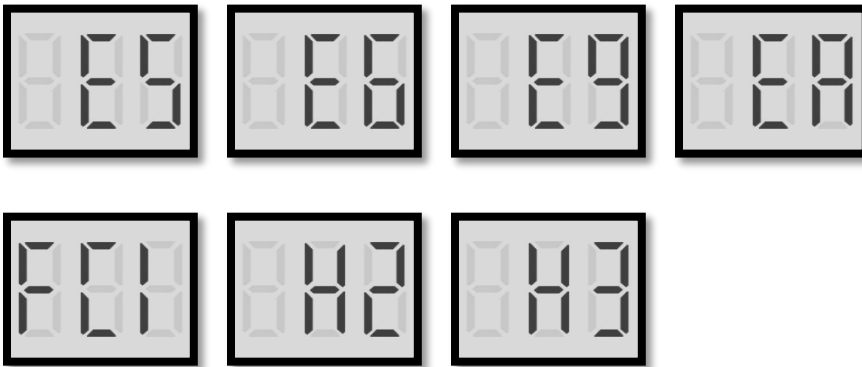

6.7.2 Description

Code	Description	Port	Location
E5	T3 Outdoor unit heat exchanger bottom temperature sensor error	CN34	<p>The 'Location' column contains two photographs of a green printed circuit board (PCB). The left photograph shows the top side of the board with a red box highlighting a specific sensor connection point. The right photograph shows the bottom side of the board with a red box highlighting another sensor connection point. Both boxes are red and rectangular.</p>
E6	T4 Ambient temperature sensor error	CN45	
E9	Th Return-air temperature sensor error	CN5	
EA	Tp Discharge temperature sensor error	CN50	
FC1	TL Outdoor unit heat exchanger outlet temperature sensor error	CN7	
H2	T2 Plate heat exchanger outlet refrigerant temperature sensor error	CN47	
H3	T2B Plate heat exchanger inlet refrigerant temperature sensor error		

6.7.3 Procedure

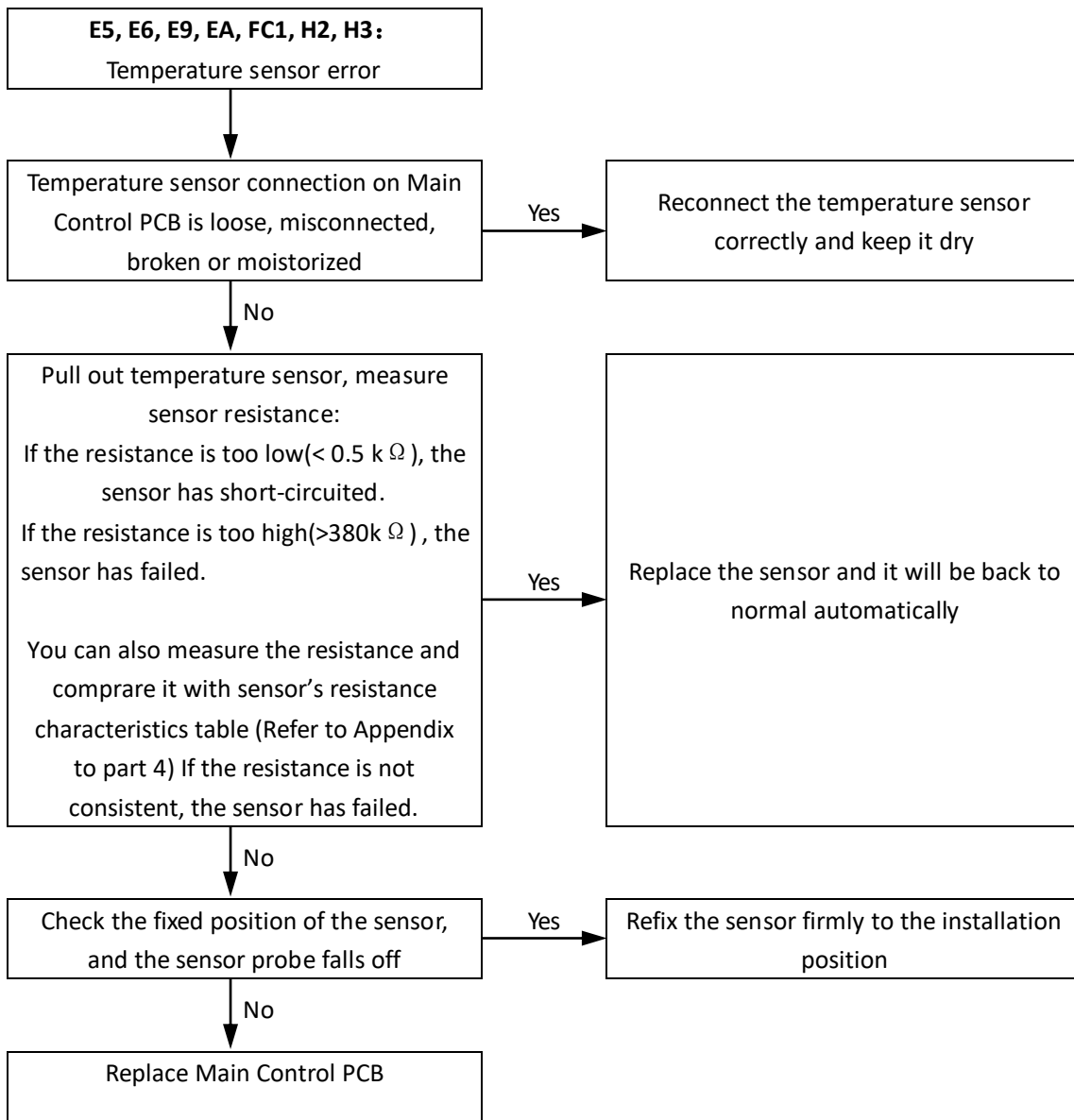

6.8 E3, E4, E7, Eb, EC, Ed, HA, H9 Troubleshooting

6.8.1 Digital display output

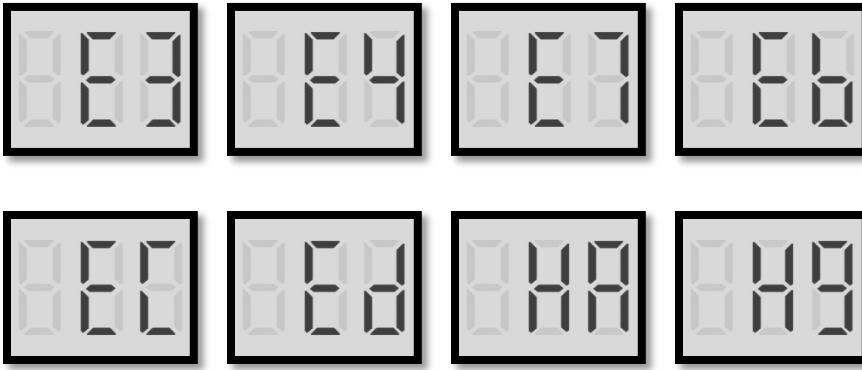

6.8.2 Description

Code	Description	Port	Location (Main Control PCB)																
E3	T1 Electric Heater/AHS water outlet temperature sensor error	CN39																	
E4	T5 Water tank temperature sensor error	CN13																	
E7	Tbt Balance tank temperature sensor/ Final outlet water temperature of cascade system sensor error	CN24																	
Eb	Tsolar Solar panel temperature sensor error	CN18																	
EC	T5_2 Water tank temperature sensor error (Reserved)	CN38																	
Ed	Tw_in Plate heat exchanger inlet water temperature sensor error	CN10																	
HA	Tw_out Plate heat exchanger outlet water temperature sensor error																		
H9	Tw2 Zone 2 water flow temperature sensor error	CN15																	
Dip Switch S1	IBH Dip switch			<table border="1"> <thead> <tr> <th>DIP switch</th> <th>ON=1</th> <th>OFF=0</th> <th>FACTORY SETTINGS</th> </tr> </thead> <tbody> <tr> <td rowspan="3">S1</td> <td>0/0= Model 1</td> <td>1/0= Model 2</td> <td rowspan="3">1:OFF 2:OFF</td> </tr> <tr> <td>0/1= Model 3</td> <td>1/1= Model 4</td> </tr> <tr> <td>0/0=Without crankcase heater IBH</td> <td>0/1=With crankcase heater IBH(One-step control)</td> <td rowspan="3">3:OFF 4:OFF</td> </tr> <tr> <td>1/0=With crankcase heater IBH(Two-step control)</td> <td>1/1=With crankcase heater IBH(Three-step control)</td> </tr> </tbody> </table>	DIP switch	ON=1	OFF=0	FACTORY SETTINGS	S1	0/0= Model 1	1/0= Model 2	1:OFF 2:OFF	0/1= Model 3	1/1= Model 4	0/0=Without crankcase heater IBH	0/1=With crankcase heater IBH(One-step control)	3:OFF 4:OFF	1/0=With crankcase heater IBH(Two-step control)	1/1=With crankcase heater IBH(Three-step control)
DIP switch	ON=1	OFF=0	FACTORY SETTINGS																
S1	0/0= Model 1	1/0= Model 2	1:OFF 2:OFF																
	0/1= Model 3	1/1= Model 4																	
	0/0=Without crankcase heater IBH	0/1=With crankcase heater IBH(One-step control)		3:OFF 4:OFF															
1/0=With crankcase heater IBH(Two-step control)	1/1=With crankcase heater IBH(Three-step control)																		

Note 1: Dip switch settings or User Interface settings

Code	Description
Ed	Main Control PCB can not detect the right sensor value.
HA	
E3	IBH function is on(Dip switch S1-3/4 is set IBH available, and User Interface- For Serviceman - Other heat source – IBH function=1) ,while Main Control PCB can not detect the right T1 sensor value. AHS function is on (User Interface- For Serviceman - Other heat source - AHS function=1), while Main Control PCB can not detect the right T1 sensor value.
E4	DHW mode is on (User Interface- For Serviceman - DHWsetting- DHW mode=1), while Main Control PCB can not detect the right T5 sensor value.
E7	Tbt is on (User Interface- For Serviceman- Input definition- Tbt=1), while Main Control PCB can not detect the right Tbt sensor value.
Eb	Solar function is on and Solar control is on (User Interface- For Serviceman - Other heat source - Solar function=1 & Solar control=1),while Main Control PCB can not detect the right Tsolar sensor value.
EC	T5_2 is on (User Interface- For Serviceman- Input definition- Tbt=1), while Main Control PCB can not detect the right T5_2 sensor value. (Reserved)
H9	Double zone is on(User Interface- For Serviceman –Temp. type setting – Double zone=1),while Main Control PCB can not detect the right Tw2 sensor value.

6.8.3 Procedure

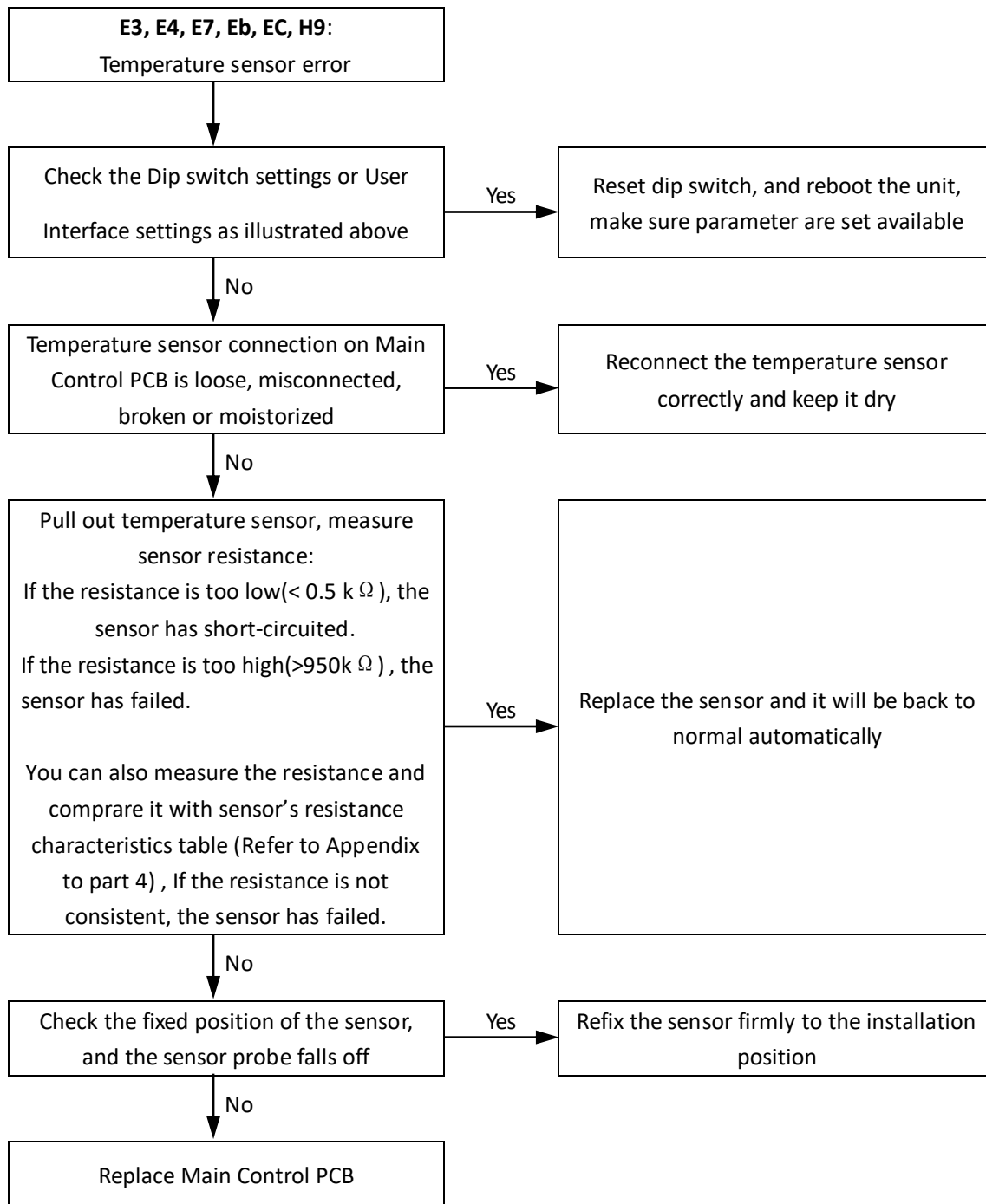

6.9 H5 Troubleshooting

6.9.1 Digital display output



6.9.2 Description

Code	Description	Location
H5	Ta room temperature sensor error	Inserted on PCB of User Interface

6.9.3 Procedure

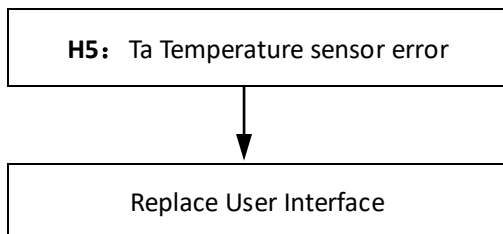

6.10 H8, P21, P27 Troubleshooting

6.10.1 Digital display output



6.10.2 Description

Code	Description	Port	Location(Main Control PCB)
H8	H-SEN High pressure sensor error	CN3	<p>The image shows the Main Control PCB with two views. The left view shows the entire board with a red box highlighting the sensor error location. The right view is a close-up of the sensor error location, showing a red box around a yellow and red connector.</p>
P21	L-SEN Low pressure sensor error	CN46	
P27	H-SEN and L-SEN connected reversely (Detect when compressor is off)	CN3/ CN46	

6.10.3 Procedure

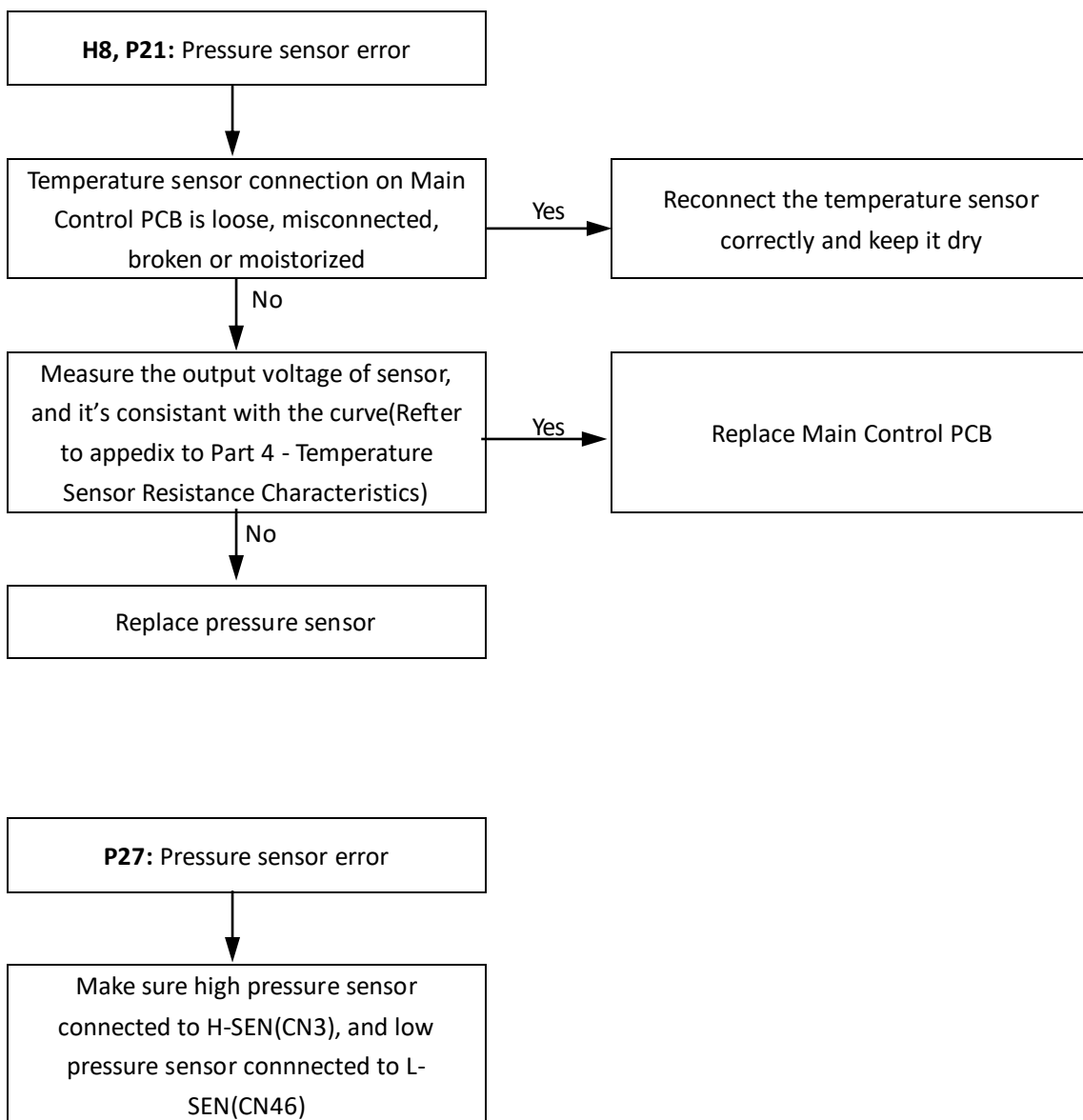

6.11 E1 Troubleshooting

6.11.1 Digital display output



6.11.2 Description

Error code		E1 (For 3Ph models)
Description		Phase loss or phase reversal
Triggering		At least one of L1/L2/L3/N misconnected or disconnected
Relative ports and locations	Terminal blocks	A photograph showing the internal components of the unit. On the left, a terminal block has four terminals labeled 'N', 'L3', 'L2', and 'L1'. On the right, a green printed circuit board (PCB) is visible with various electronic components. A red box highlights a specific area on the PCB. A yellow warning label is visible at the bottom of the terminal block area.

6.11.3 Procedure

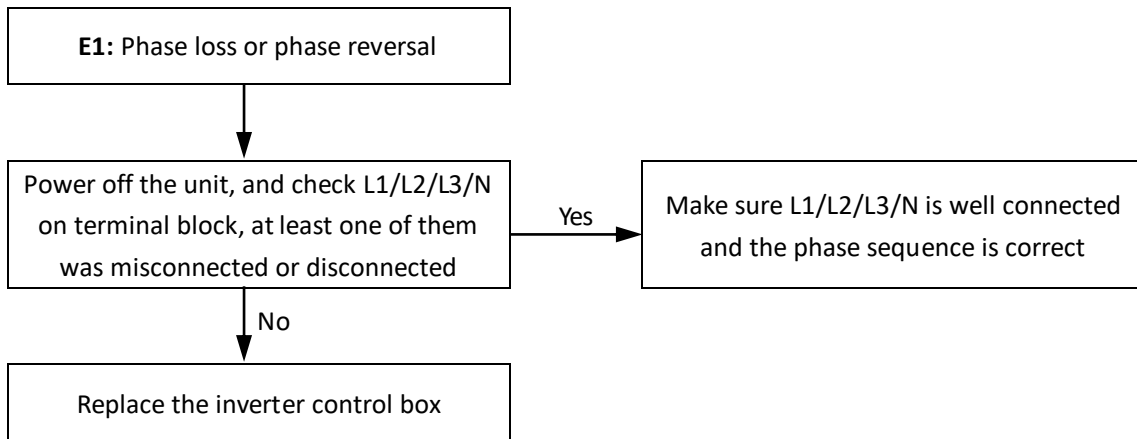

6.12 H7 Troubleshooting

6.12.1 Digital display output

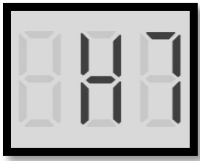

6.12.2 Description

Error code	H7
Description	Power overvoltage and Power undervoltage protection
Triggering	Input voltage <math>< 170V</math> or Input voltage $\geq 265V</math>(The unit will back to normal if input voltage \geq 180V</math> or input voltage \leq 250V</math>)$

6.12.3 Procedure

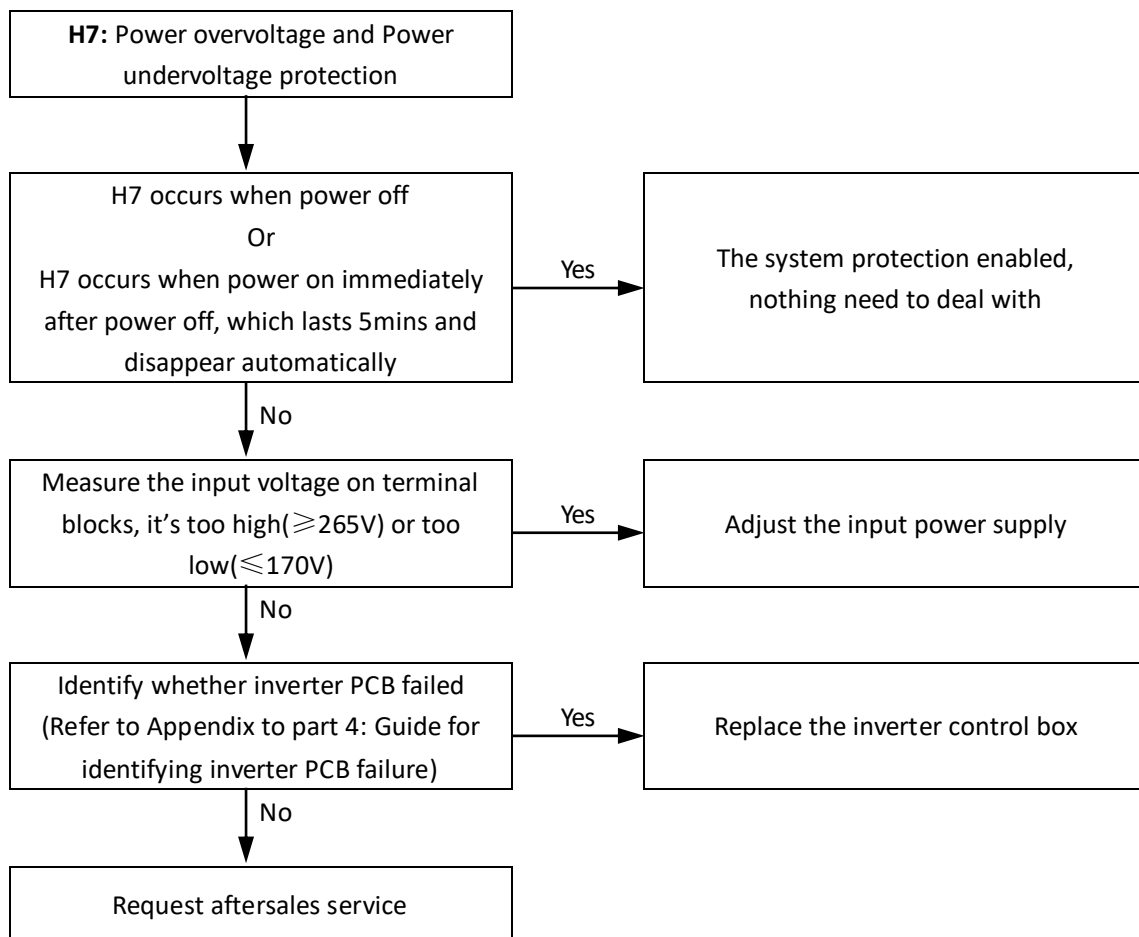

6.13 P0 Troubleshooting

6.13.1 Digital display output

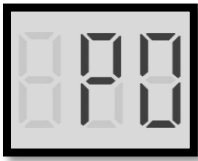

6.13.2 Description

Error code	P0
Description	Low pressure protection
Triggering	The Main Control PCB detected that the low pressure was < 0.13Mpa and lasts 5 seconds

6.13.3 Procedure

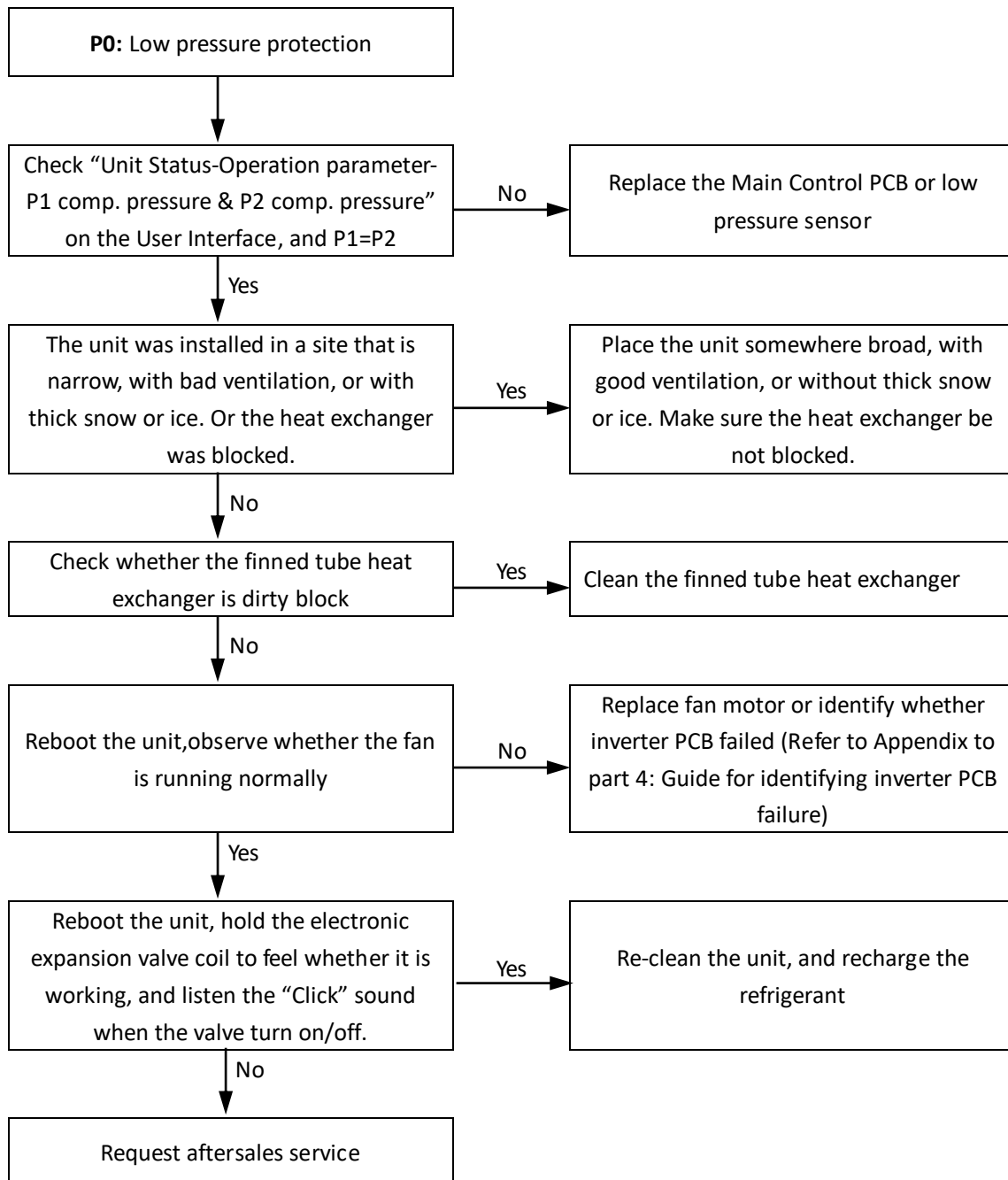

6.14 P1 Troubleshooting

6.14.1 Digital display output

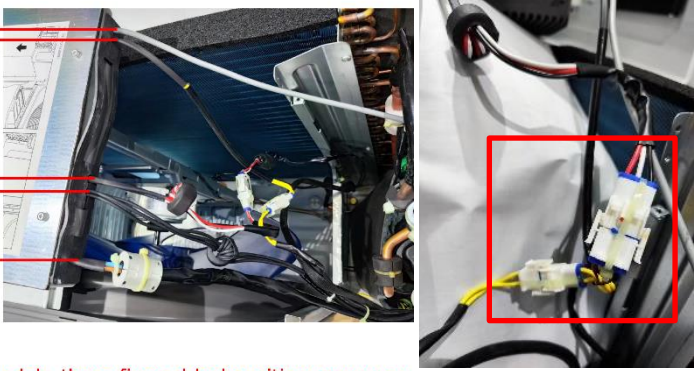

6.14.2 Description

Error code	P1																
Description	High pressure switch protection																
Triggering	The Main Control PCB detected that the high pressure was ≥ 3.5 Mpa																
High pressure switch location	The location of high pressure switch refer to Part 2 Component Layout and Refrigerant Circuits																
High pressure switch plug	<p style="text-align: center; color: red;">The Cables from Inverter Control box</p> <div style="display: flex; align-items: center;"> <div style="margin-right: 10px;"> <p style="color: red;">Communication Cable</p> <p style="color: red;">High Pressure Switch Cable</p> <p style="color: red;">Fan Connection Cable</p> <p style="color: red;">Compressor Connection Cable</p> <p style="color: red;">Power Cable</p> </div>  </div> <p style="color: red; text-align: center;">Note: For different models, these five cables' position may vary.</p>																
Make sure water pressure and water flow rate is in the proper range	<p>The proper water pressure range:(0.3bar-3bar)</p> <div style="border: 1px solid gray; padding: 5px; margin: 10px 0;"> <ul style="list-style-type: none"> • The water pressure will vary with the water temperature (a higher pressure at a higher water temperature). Always keep the water pressure above 0.3 bar to prevent air from entering the loop. • The unit might drain off too much water through the pressure relief valve. </div> <div style="border: 1px solid gray; padding: 5px; margin: 10px 0; text-align: center;"> <p>Maximum water pressure 3 bar</p> </div> <p>The proper water flow rate range</p> <table border="1" style="width: 100%; border-collapse: collapse;"> <thead> <tr> <th style="width: 50%;">Unit</th> <th style="width: 50%;">Flow rate range</th> </tr> </thead> <tbody> <tr> <td>4kW</td> <td>0.40 - 0.90 m³/h</td> </tr> <tr> <td>6kW</td> <td>0.40 - 1.25 m³/h</td> </tr> <tr> <td>8kW</td> <td>0.40 - 1.65 m³/h</td> </tr> <tr> <td>10kW</td> <td>0.40 - 2.10 m³/h</td> </tr> <tr> <td>12kW</td> <td>0.70 - 2.50 m³/h</td> </tr> <tr> <td>14kW</td> <td>0.70 - 2.75 m³/h</td> </tr> <tr> <td>16kW</td> <td>0.70 - 3.00 m³/h</td> </tr> </tbody> </table>	Unit	Flow rate range	4kW	0.40 - 0.90 m ³ /h	6kW	0.40 - 1.25 m ³ /h	8kW	0.40 - 1.65 m ³ /h	10kW	0.40 - 2.10 m ³ /h	12kW	0.70 - 2.50 m ³ /h	14kW	0.70 - 2.75 m ³ /h	16kW	0.70 - 3.00 m ³ /h
Unit	Flow rate range																
4kW	0.40 - 0.90 m ³ /h																
6kW	0.40 - 1.25 m ³ /h																
8kW	0.40 - 1.65 m ³ /h																
10kW	0.40 - 2.10 m ³ /h																
12kW	0.70 - 2.50 m ³ /h																
14kW	0.70 - 2.75 m ³ /h																
16kW	0.70 - 3.00 m ³ /h																

6.14.3 Procedure

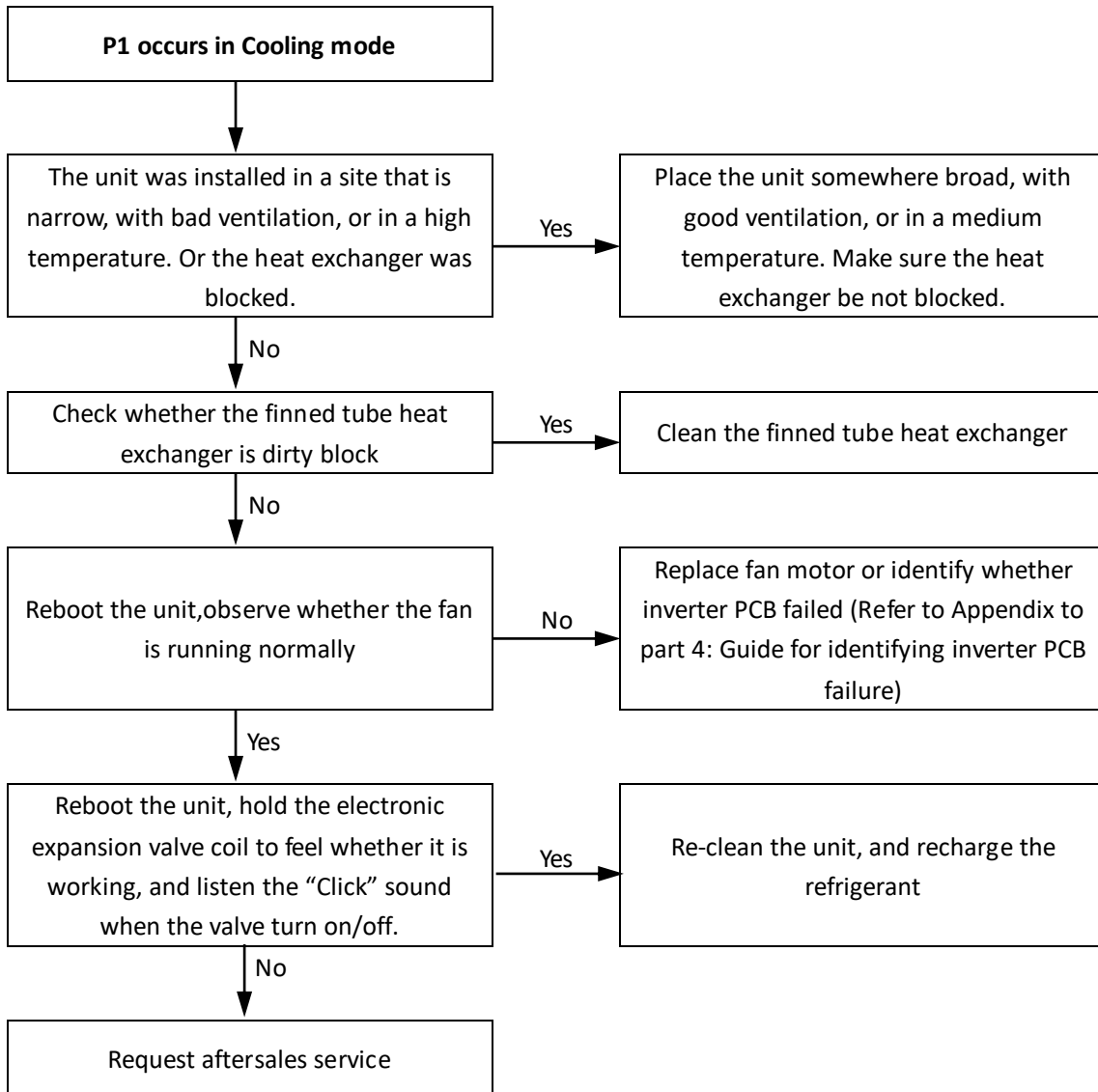

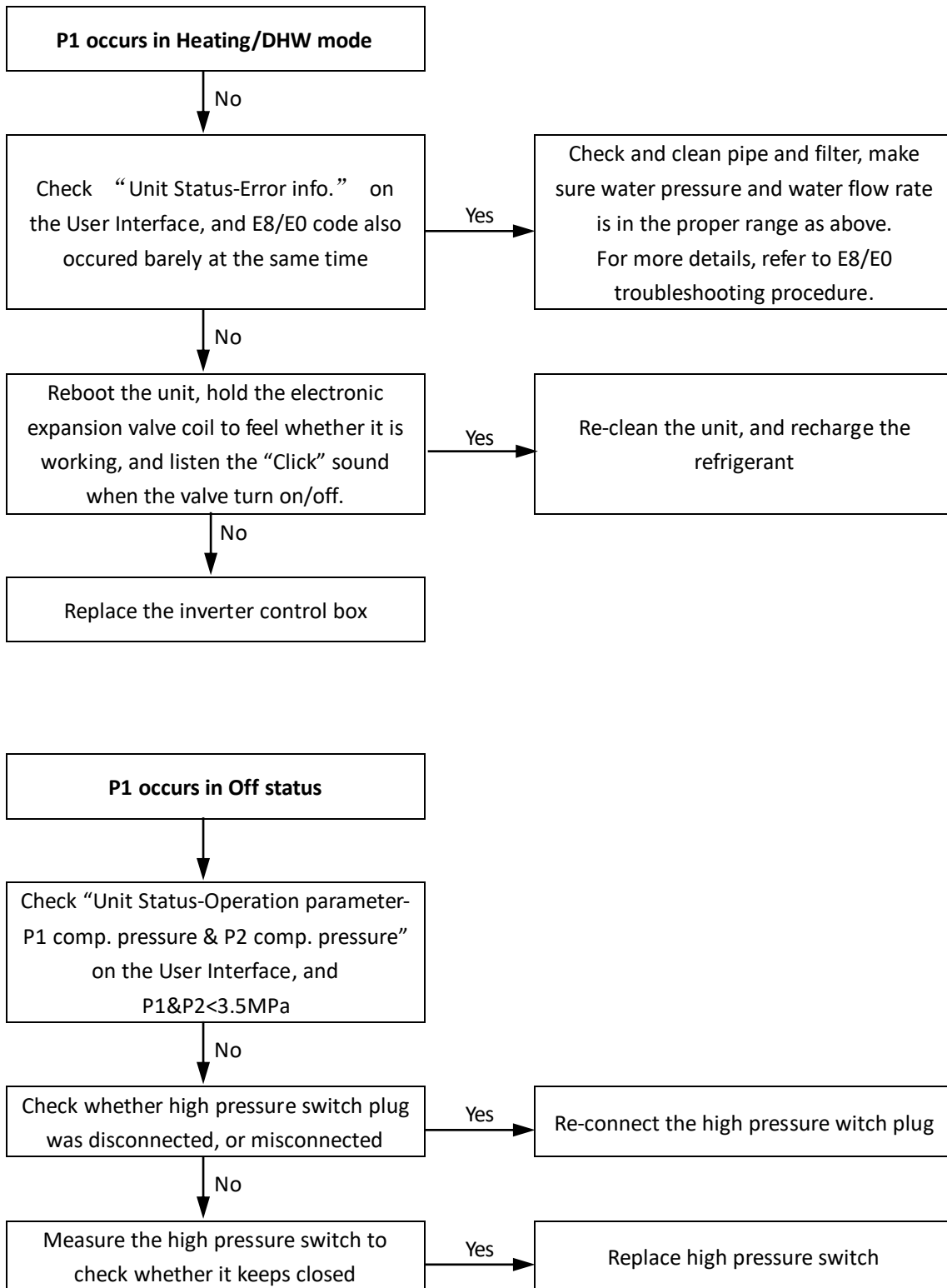



6.15 P3 Troubleshooting

6.15.1 Digital display output



6.15.2 Description

Error code	P3
Description	Overcurrent protection
Triggering	The Main Control PCB detected that the input current is higher than protection value
Terminal block	 

6.15.3 Procedure

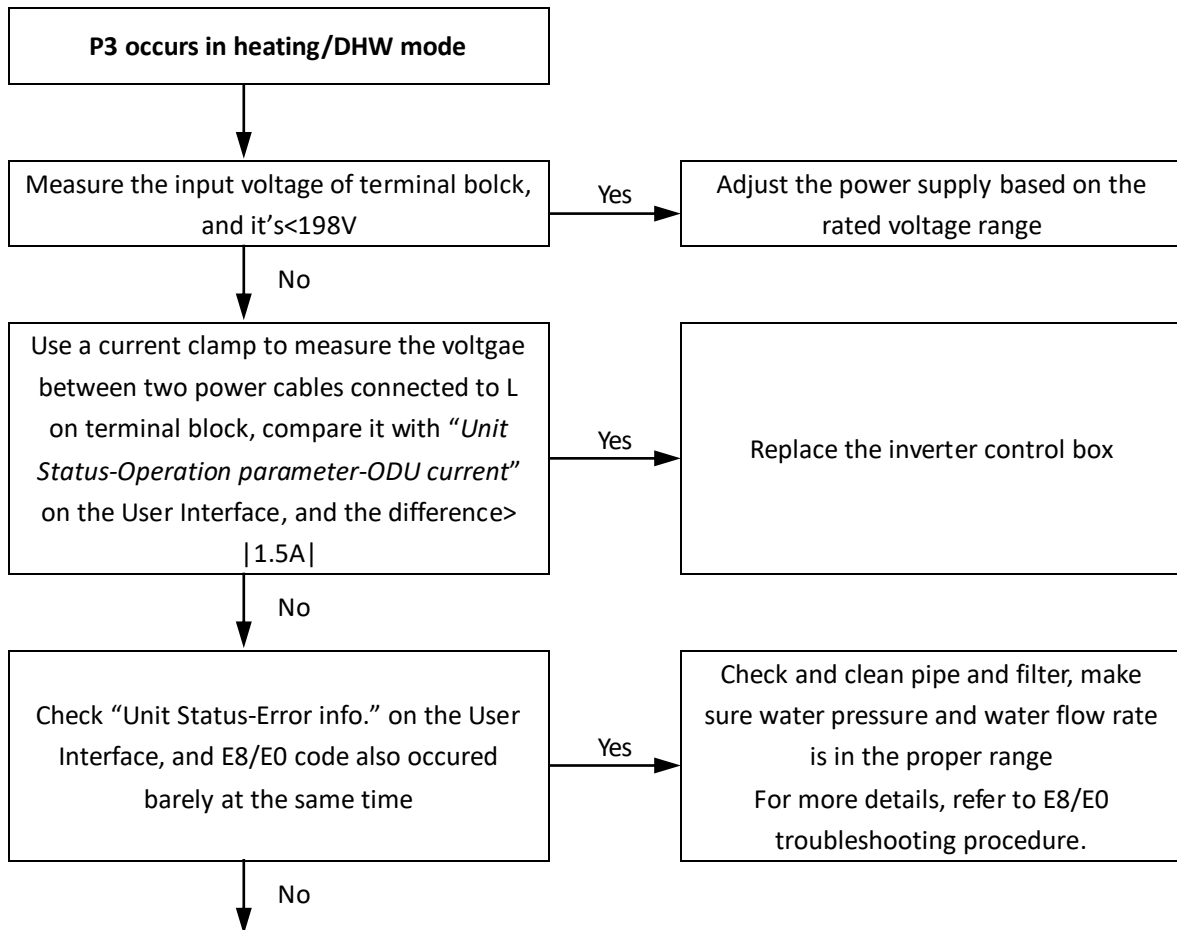

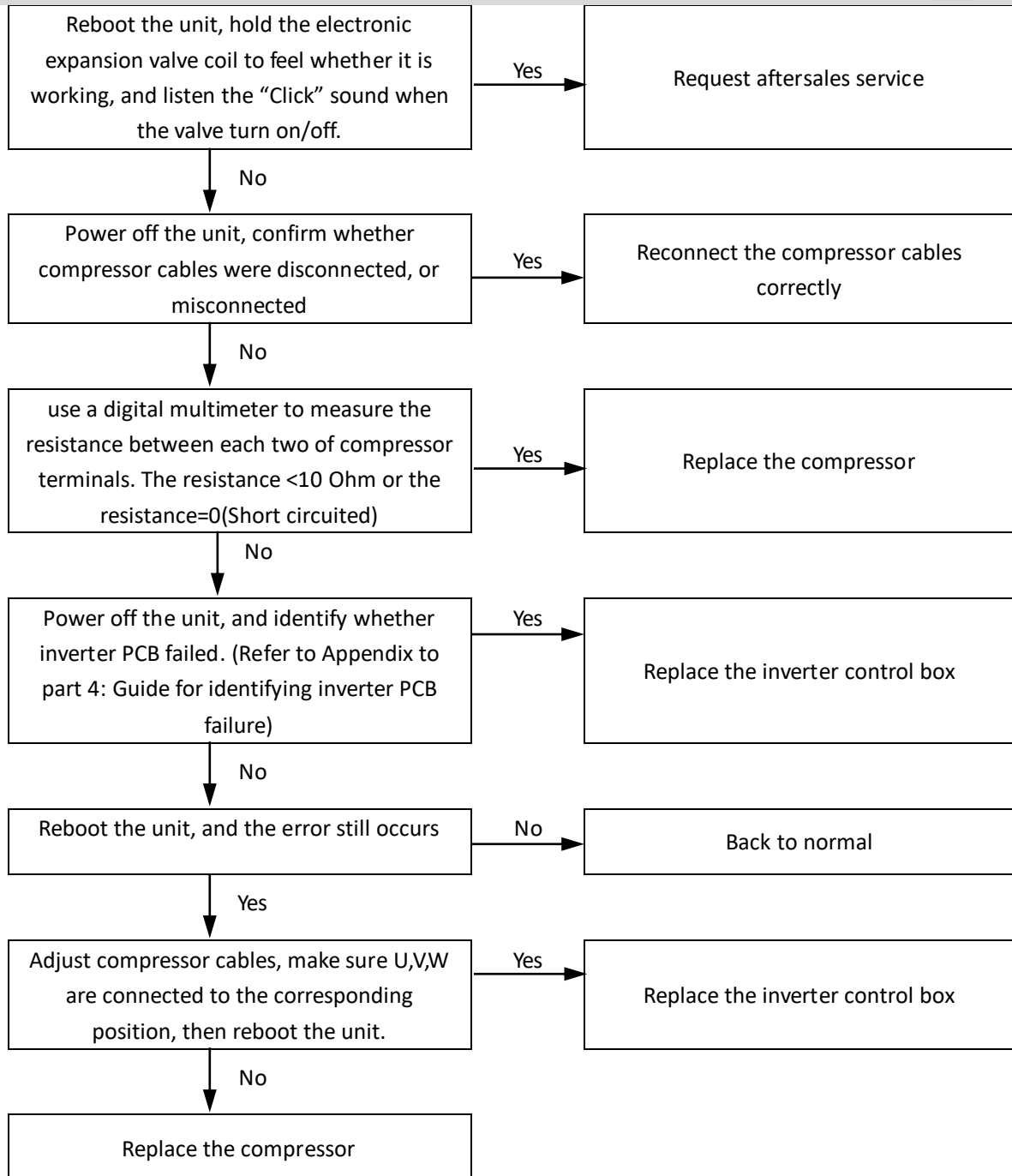

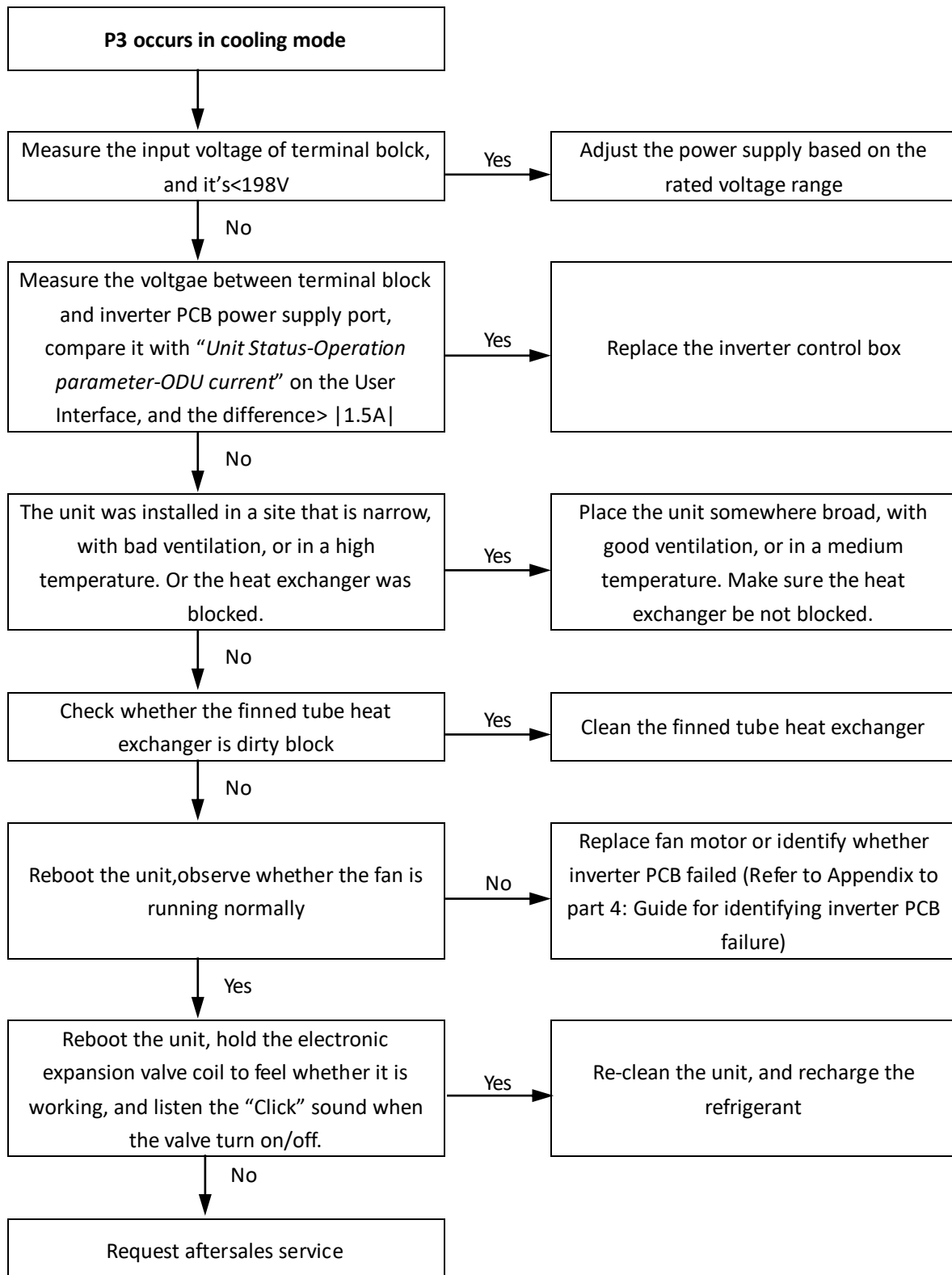

6.16 P4 Troubleshooting

6.16.1 Digital display output

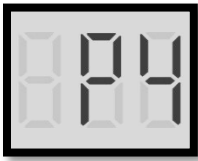

6.16.2 Description

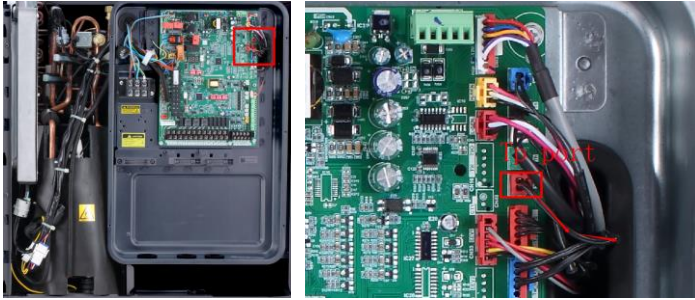
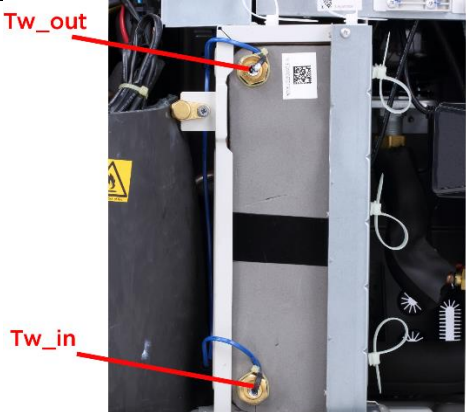
Error code		P4
Description		The protection for overhigh discharge temperature of Compressor
Triggering		The Main Control PCB detected that the compressor discharge temperature was $\geq 115^{\circ}\text{C}$
Relative ports and locations	Tp	 <p>You can find Tp sensor by the sensor cable from Tp port</p>
	Tw_in Tw_out	

6.16.3 Procedure

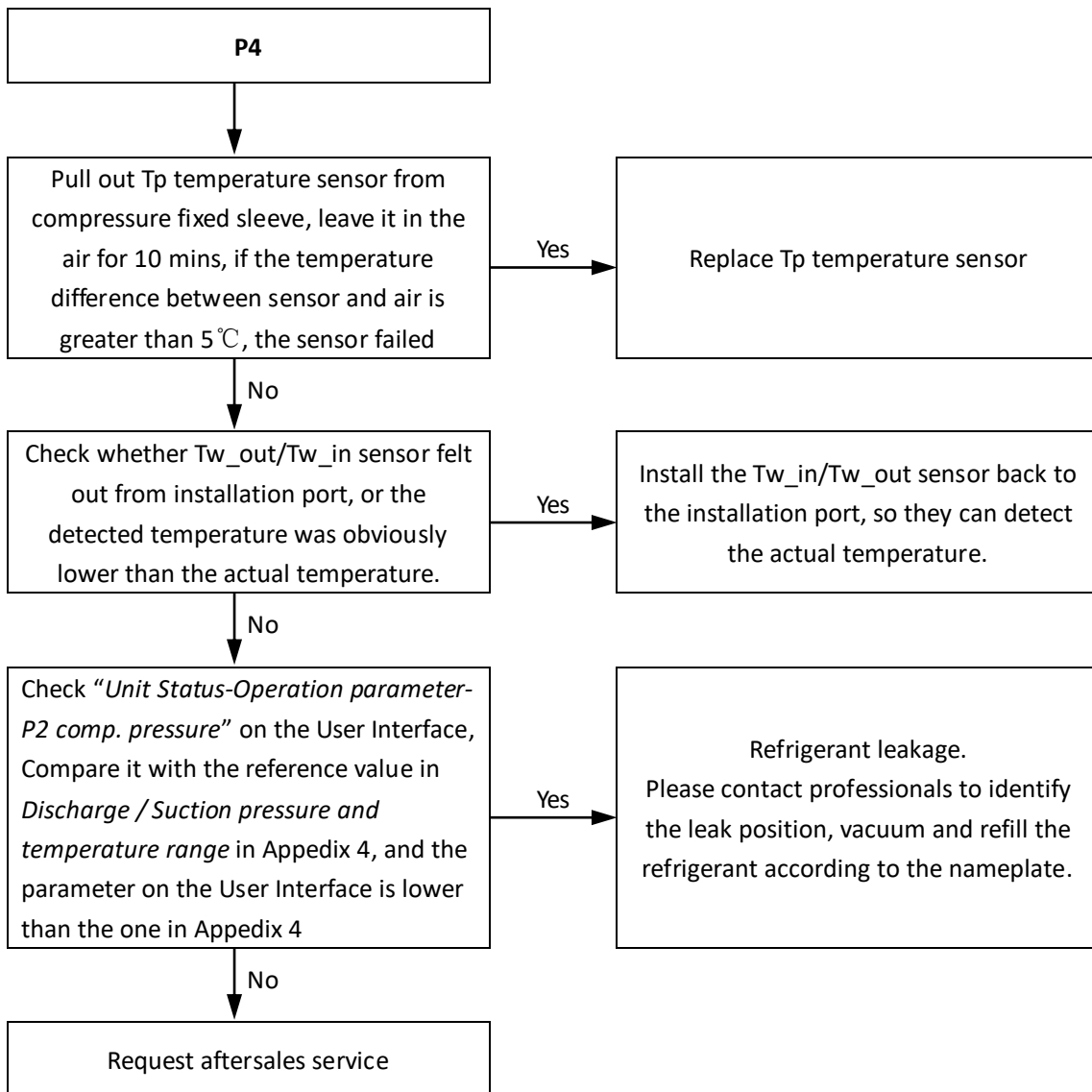

6.17 Pd Troubleshooting

6.17.1 Digital display output



6.17.2 Description

Error code	Pd
Description	The protection for overhigh condensing temperature
Triggering	The Main Control PCB detected that the condensing temperature was $\geq 65^{\circ}\text{C}$
Relative ports and locations	<p>The image shows two views of the Main Control PCB. The left view is a full view of the board with a red box highlighting the sensor connector area. The right view is a close-up of the sensor connector area, showing two connectors: a yellow one labeled 'H-SEN' and a red one labeled 'L-SEN'. The red connector is also labeled 'CN46'. Other components visible include 'IC10', 'R200', and 'R345'.</p>

6.17.3 Procedure

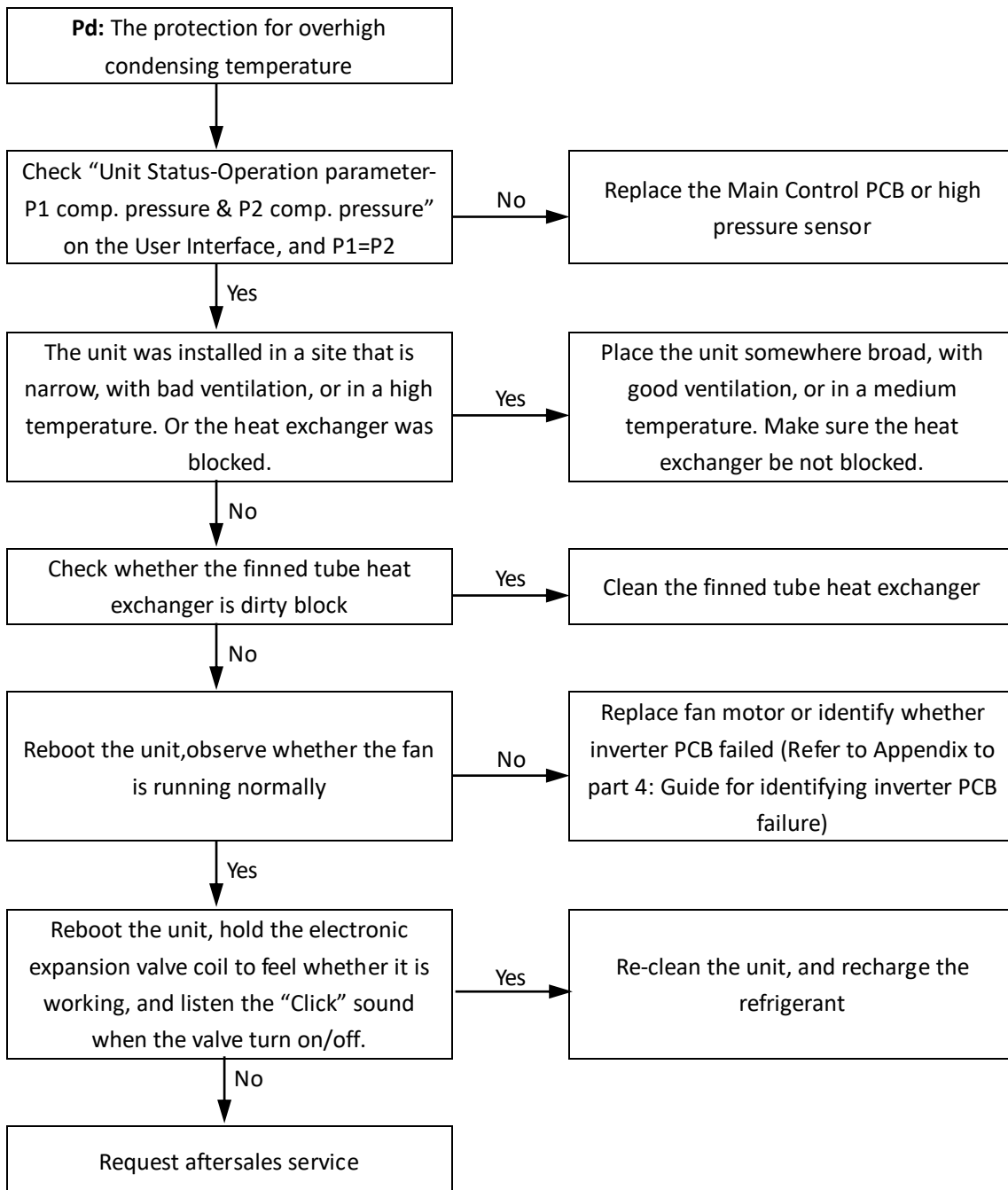

6.18 HP Troubleshooting

6.18.1 Digital display output



6.18.2 Description

Error code	HP
Description	Low pressure protection in cooling mode
Triggering	The Main Control PCB detected that the suction pressure $P_2 < 0.35\text{Mpa}$ for 5 seconds in cooling mode
Tw_in Tw_out	

6.18.3 Procedure

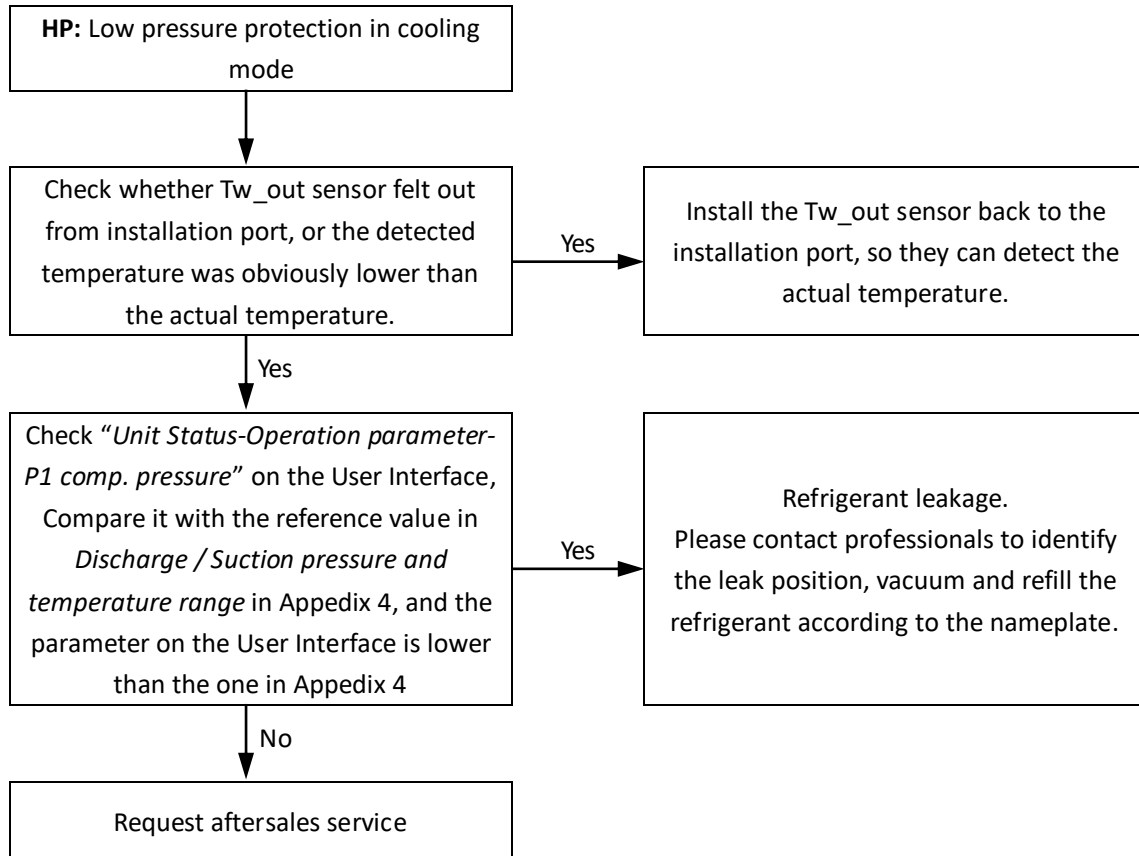

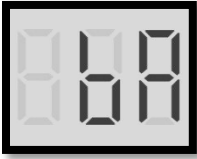

6.19 bA Troubleshooting

6.19.1 Digital display output



6.19.2 Description

Error code	bA
Description	T4 sensor out of operation protection
Triggering	In heating/ DHW mode, the error occurs when $T4 \geq 65^{\circ}\text{C}$ or $T4 < -25^{\circ}\text{C}$ In cooling mode, the error occurs when $T4 \geq 65^{\circ}\text{C}$ or $T4 < -5^{\circ}\text{C}$
T4	 

6.19.3 Procedure

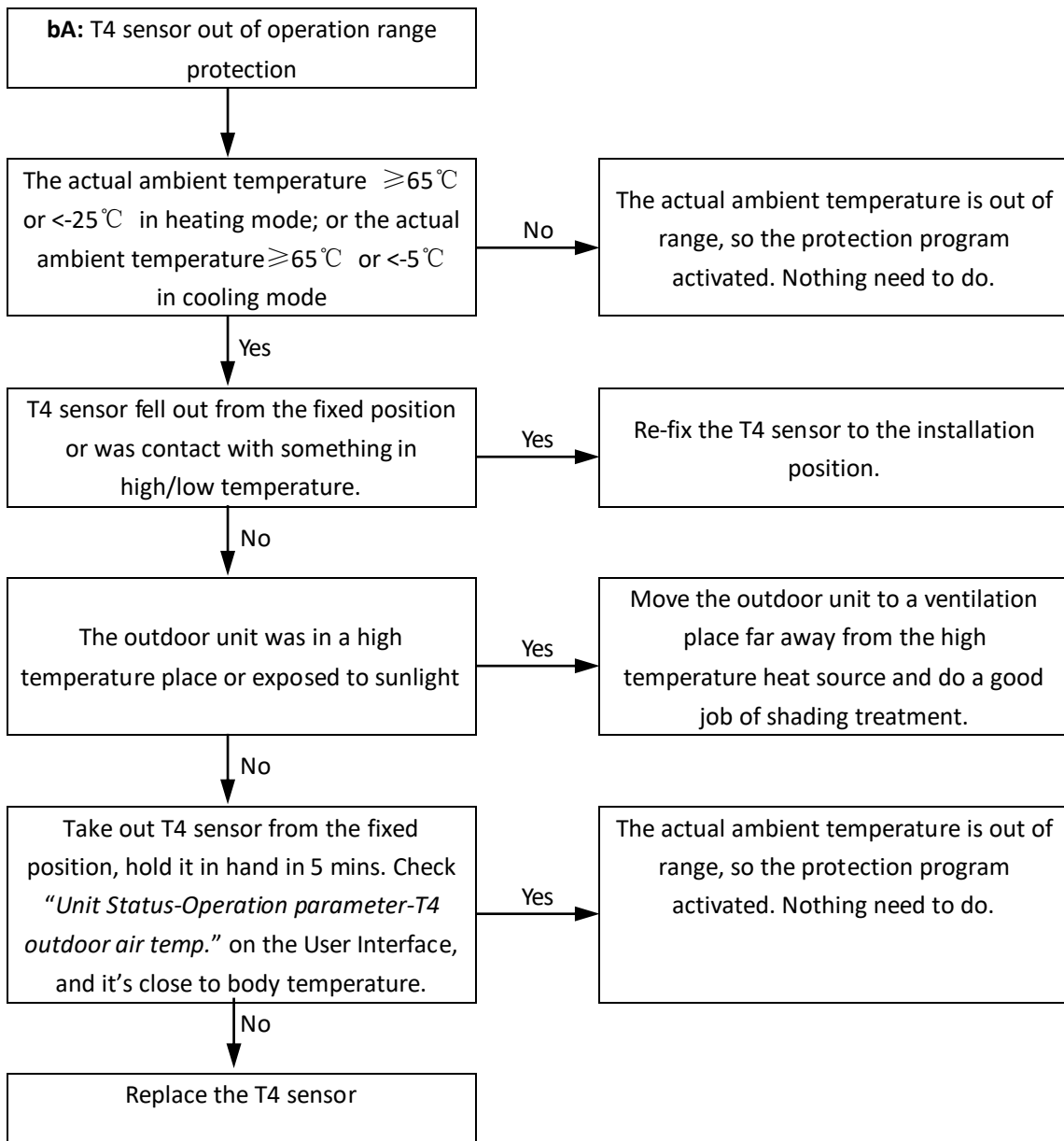

6.20 PP, Hb Troubleshooting

6.20.1 Digital display output

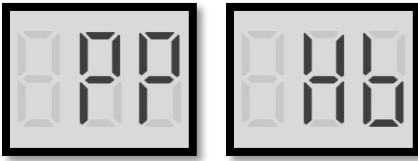

6.20.2 Description

Error code	PP	Hb
Description	The protection for abnormal temperature difference between outlet water and inlet water	3 times of PP and Twout<7°C
Triggering	Twout-Twin ≥ 3°C and lasts 15 mins in cooling mode Twin-Twout ≥ 3°C and lasts 15 mins in heating/DHW mode	
Outlet pipe and inlet pipe		
Tw_in Tw_out		
CN71 ST1 Port for 4-way valve		
For-way valve E S C		

6.20.3 Procedure

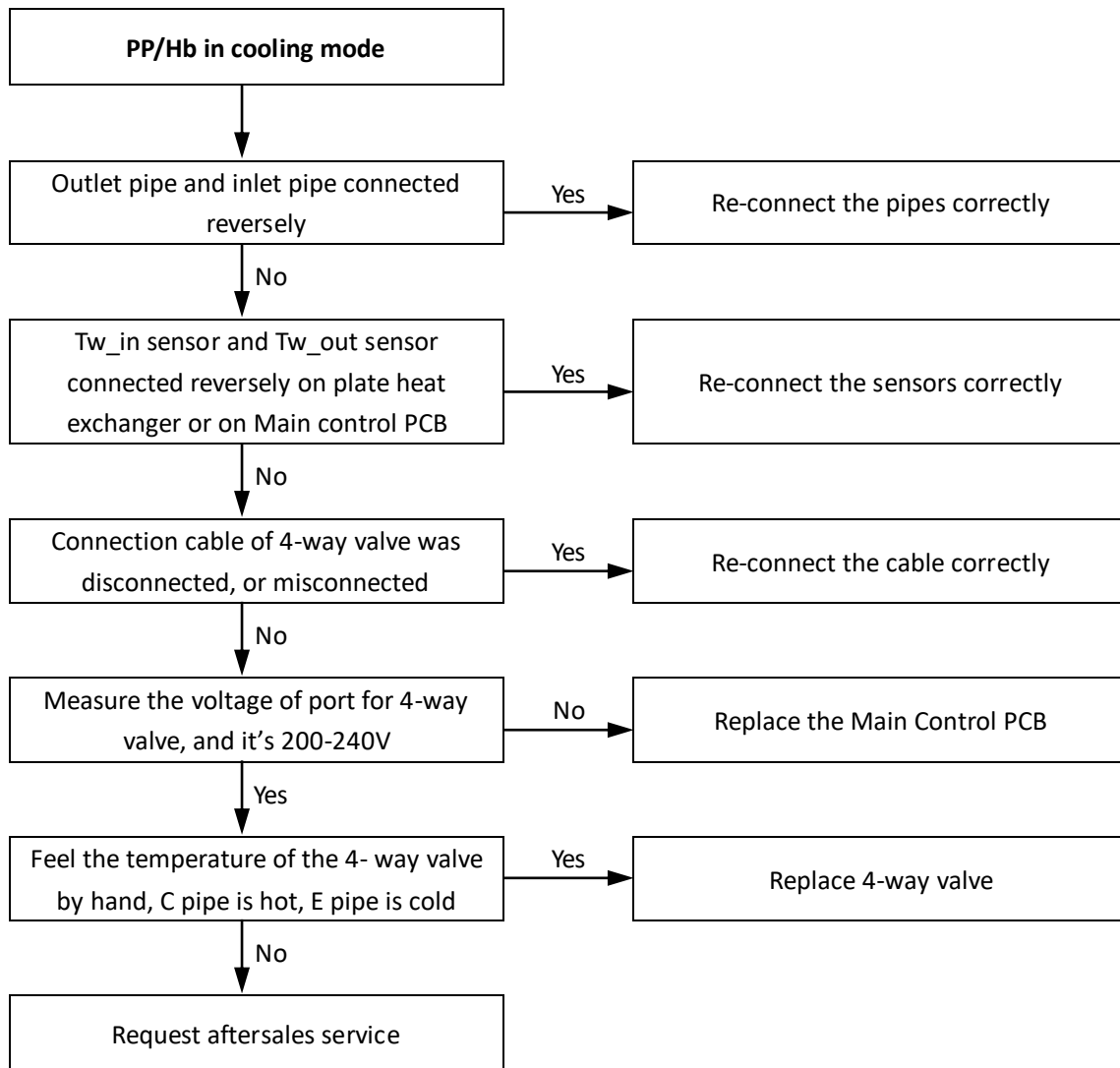

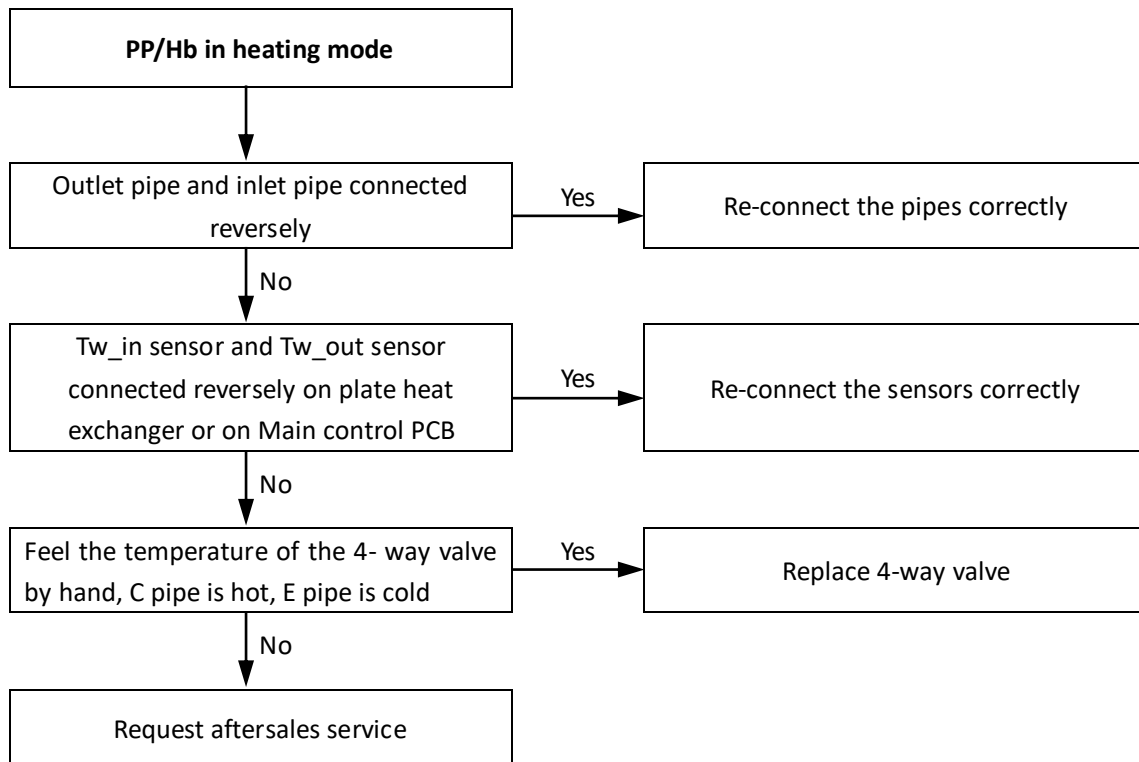

6.21 P5 Troubleshooting

6.21.1 Digital display output



6.21.2 Description

Error code	P5
Description	The big temperature difference between outlet water temp. and inlet water temp.
Triggering	$T_{out}-T_{in} \geq 30^{\circ}\text{C}$ in heating/DHW mode $T_{out}-T_{in} \geq 17^{\circ}\text{C}$ in cooling mode

6.21.3 Procedure

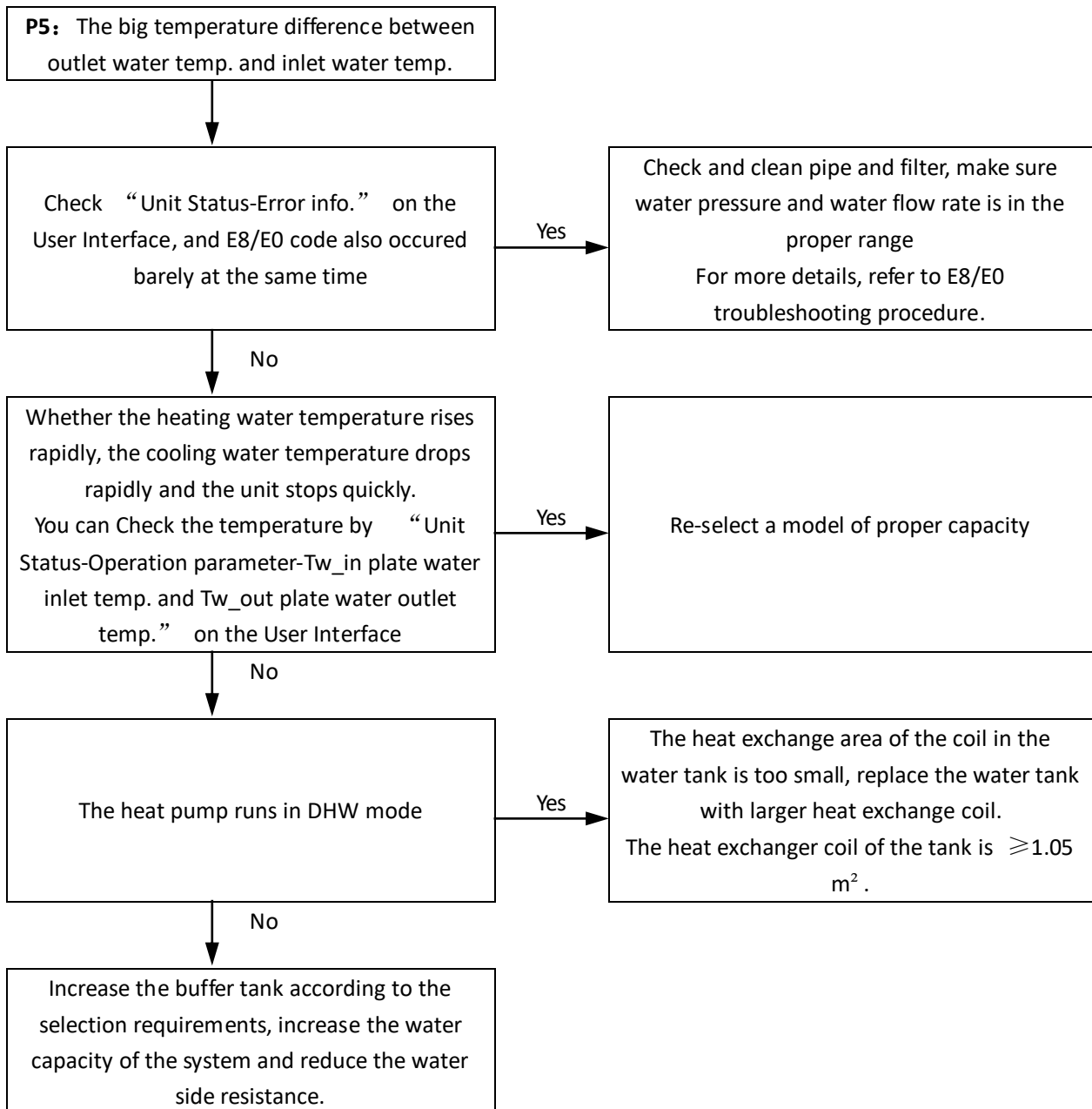

6.22 F1 Troubleshooting

6.22.1 Digital display output



6.22.2 Description

Error code	F1
Description	The protection for undervoltage of DC bus
Triggering	For single phase inverter PCB, the DC bus voltage $\leq 200\text{VDC}$ For three phase inverter PCB, the DC bus voltage $\leq 350\text{VDC}$
BUS voltage(P-N) (Inverter PCB)	

6.22.3 Procedure

For single phase:

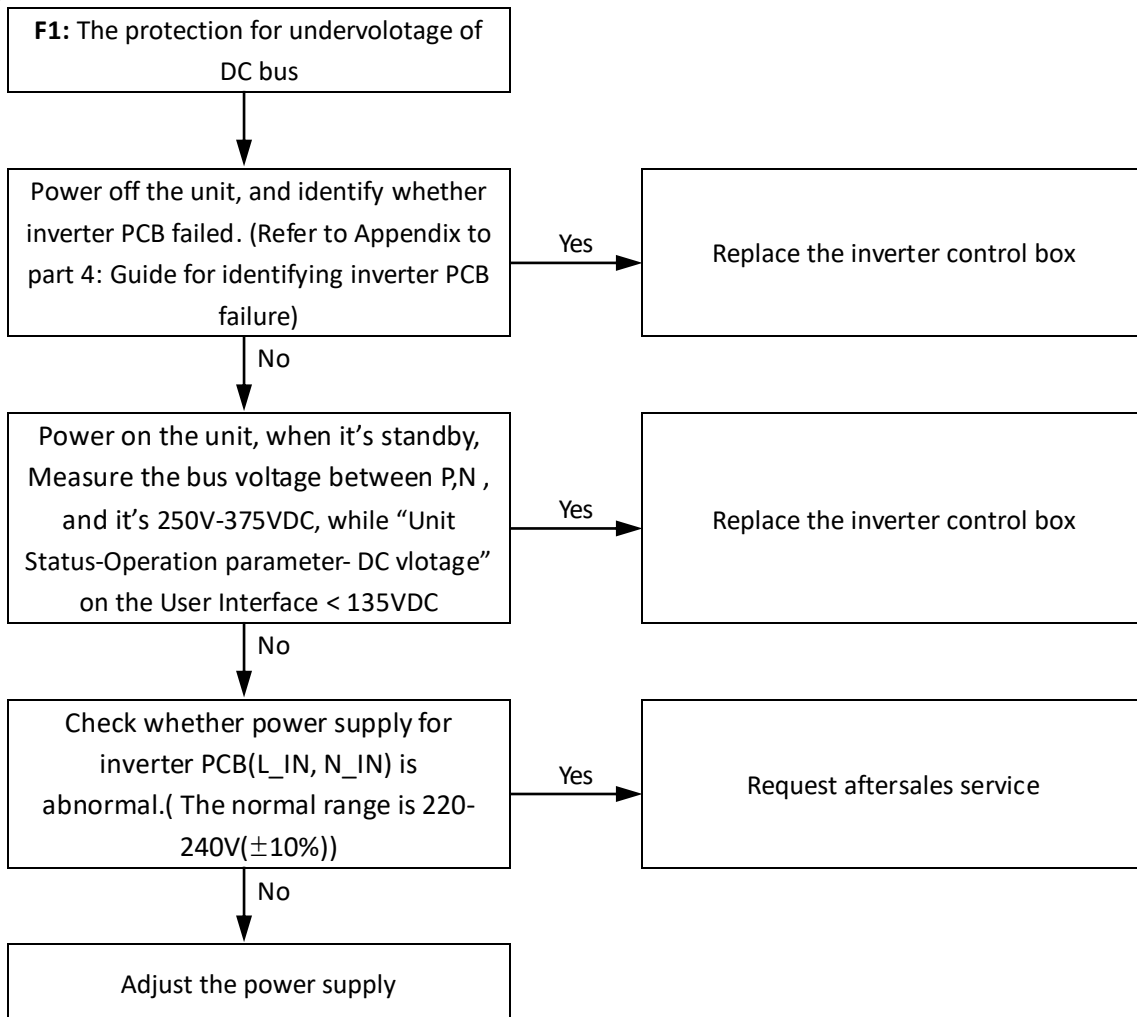

For three phase:

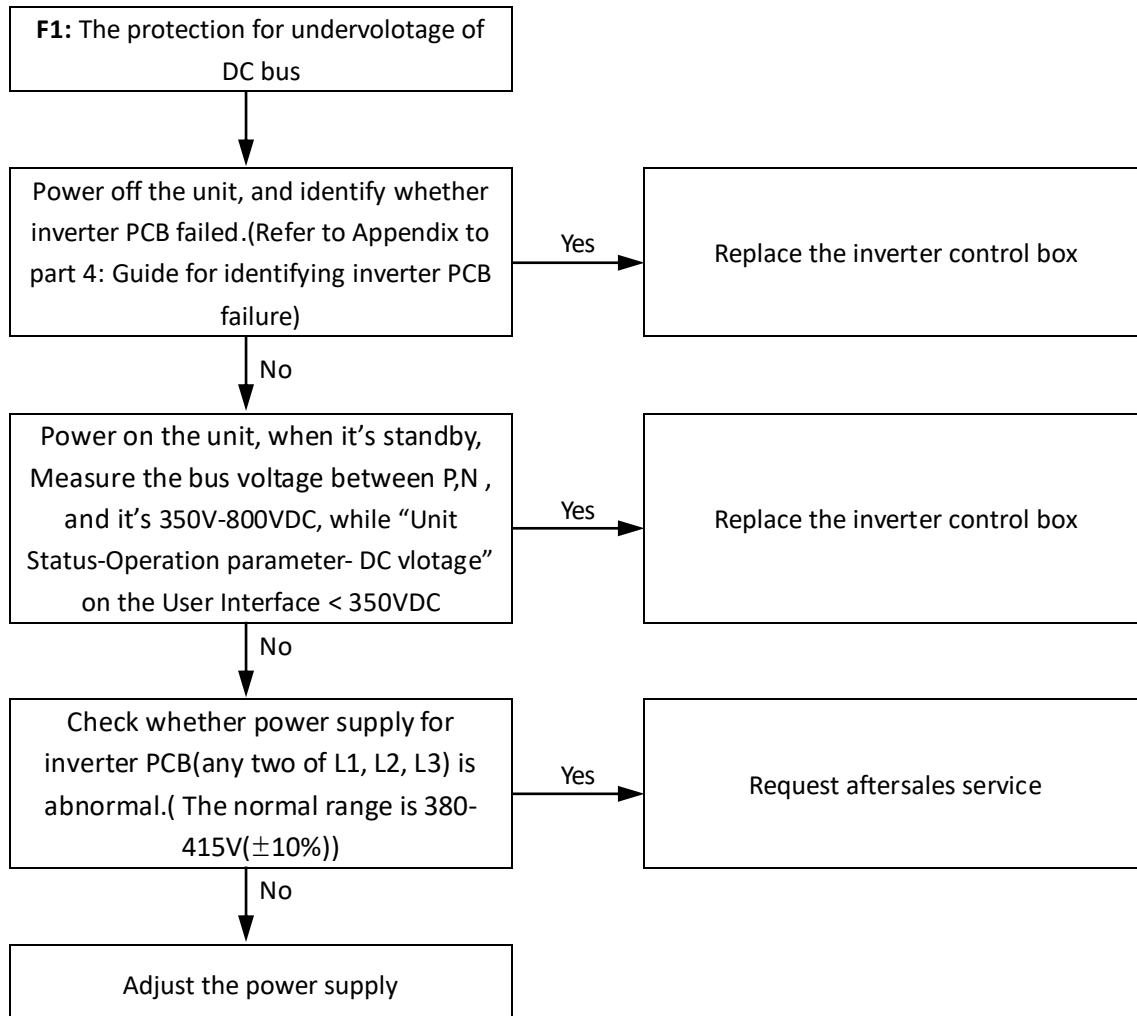

6.23 C7 Troubleshooting

6.23.1 Description

Error code	C7
Description	Overhigh temperature protection for IPM module
Triggering	IPM module temperature $\geq 95^{\circ}\text{C}$

6.23.2 Digital display output



6.23.3 Procedure

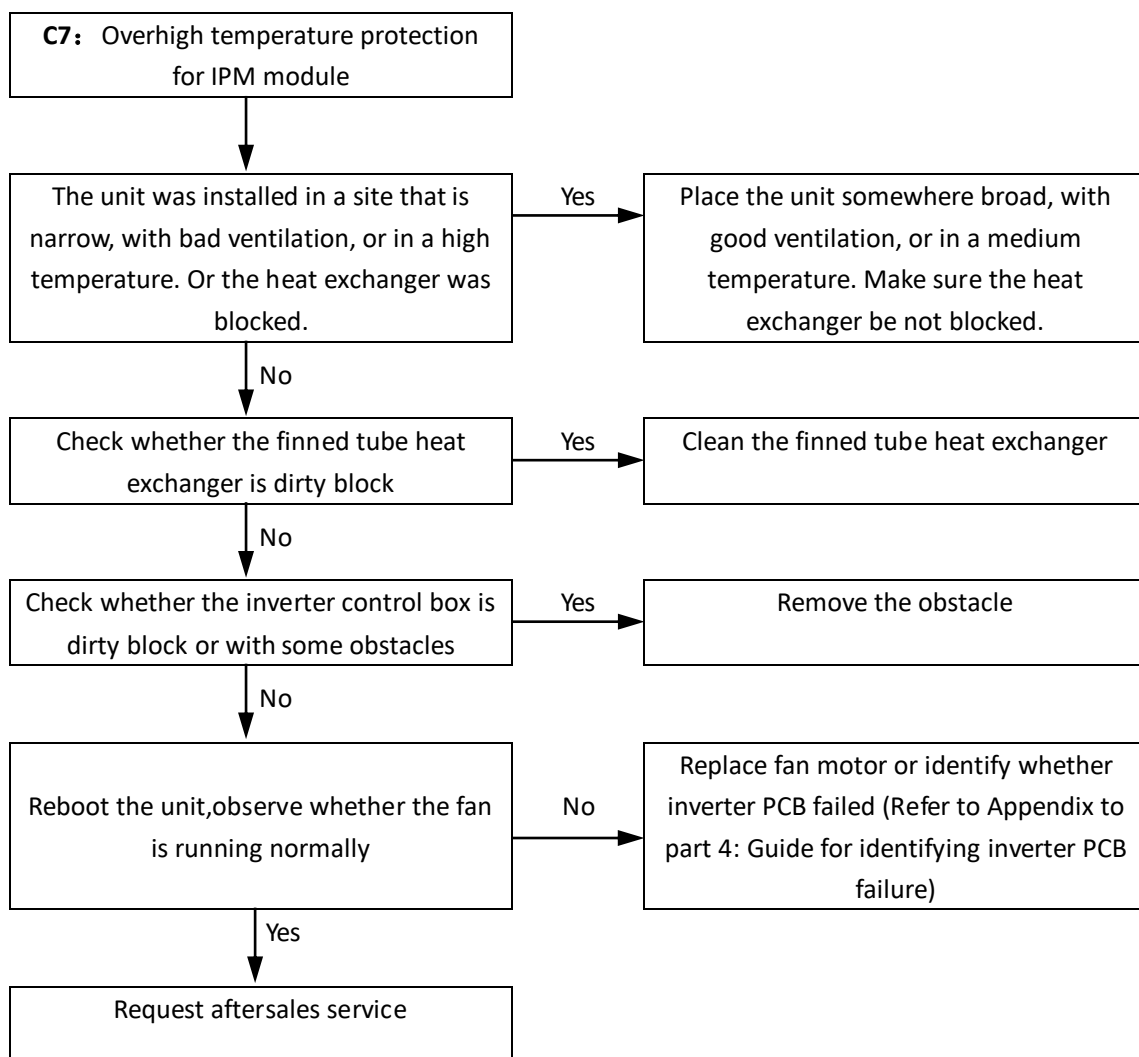

6.24 H4, L** Troubleshooting

6.24.1 Digital display output

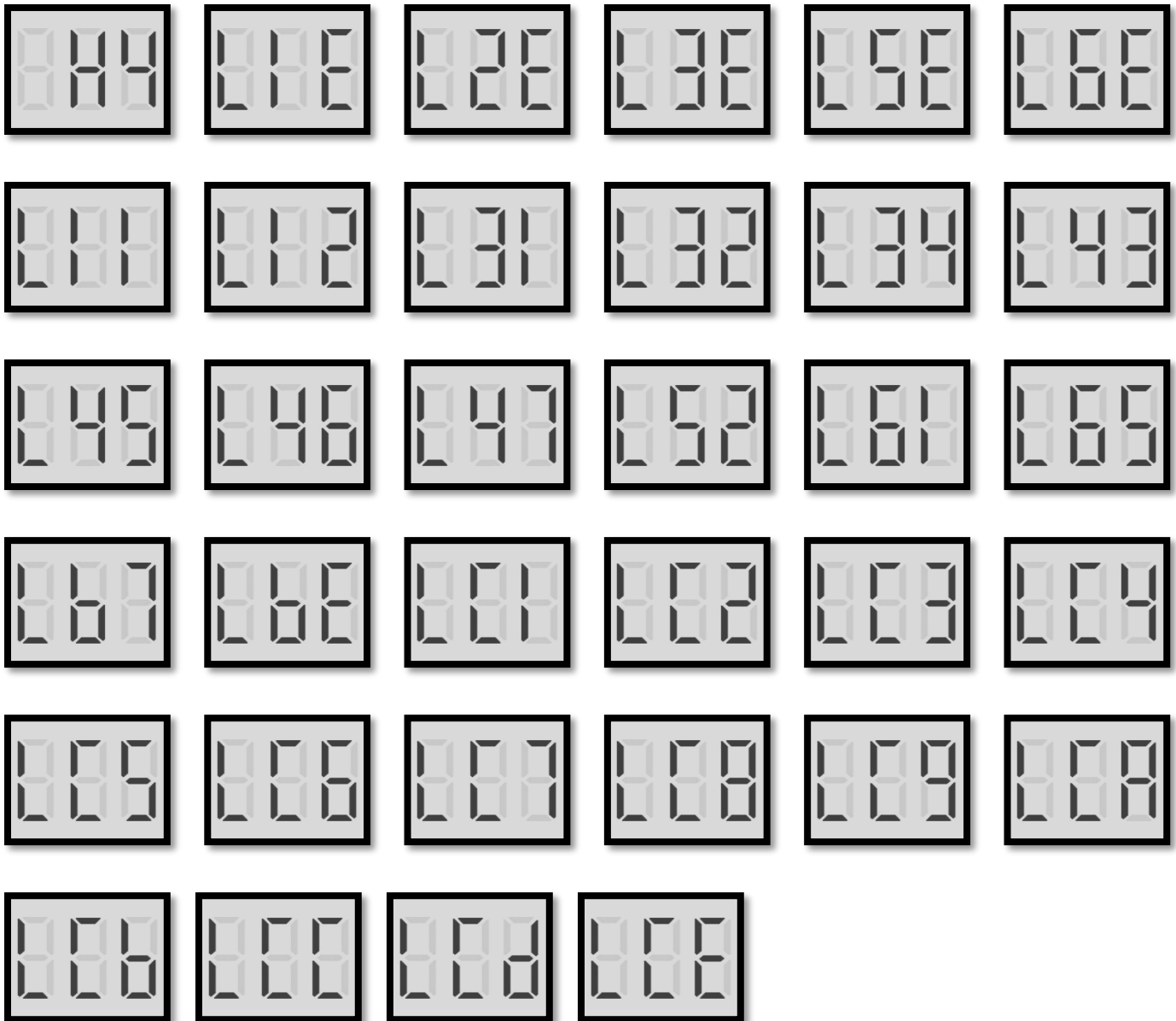

6.24.2 Description

Error code	Description	Note
H4	3 times of "L1*" in 60 mins	
L**	Inverter module protection	Chcek the specific code on digital display panel on the Main Control PCB

The specific L** code table:

Error code	Description	Note
L1E	Hardware overcurrent protection	
L11	Phase current instantaneous overcurrent protection	
L12	Phase current continuous 30s overcurrent protection	
L2E	Over-temperature protection	
L3E	Bus voltage too low error	
L31	Bus voltage too high error	

L32	Bus voltage excessively high error	
L34	Phase loss error of three-phase power supply	For 3Ph models
L43	Abnormal phase current sampling bias	
L45	Fan motor code mismatch error	
L46	IPM protection (FO)	
L47	Module type mismatch	
L5E	Motor failed to start	
L52	Motor stalling protection	
L6E	Phase loss protection	
L61	Compressor terminals short circuit protection	
L65	IPM short circuit protection	
LBE	Action of high pressure switch	
LB7	PED bH error	
LCE	PFC HARDWARE OVERCURRENT PROTECTION	For 3Ph models
LC1	Instantaneous overcurrent of pfc software protection	For 3Ph models
LC2	PFC software continuous 30 s overcurrent protection	For 3Ph models
LC3	PFC low voltage protection	For 3Ph models
LC4	PFC power factor is less than 0.8	For 3Ph models
LC5	PFC valid value overcurrent protection	For 3Ph models
LC6	PFC1 channel hardware overcurrent protection	For 3Ph models
LC7	PFC2 channel hardware overcurrent protection	For 3Ph models
LC8	PFC3 channel hardware overcurrent protection	For 3Ph models
LC9	Over-temperature protection of PFC module	For 3Ph models
LCA	PFC module CBC overcurrent error protection	For 3Ph models
LCB	Overvoltage of PFC bus or PFC half bus	For 3Ph models
LCC	Short circuit of PFC IGBT	For 3Ph models
LCD	Abnormal PFC Ad sampling bias	For 3Ph models

6.24.3 Procedure

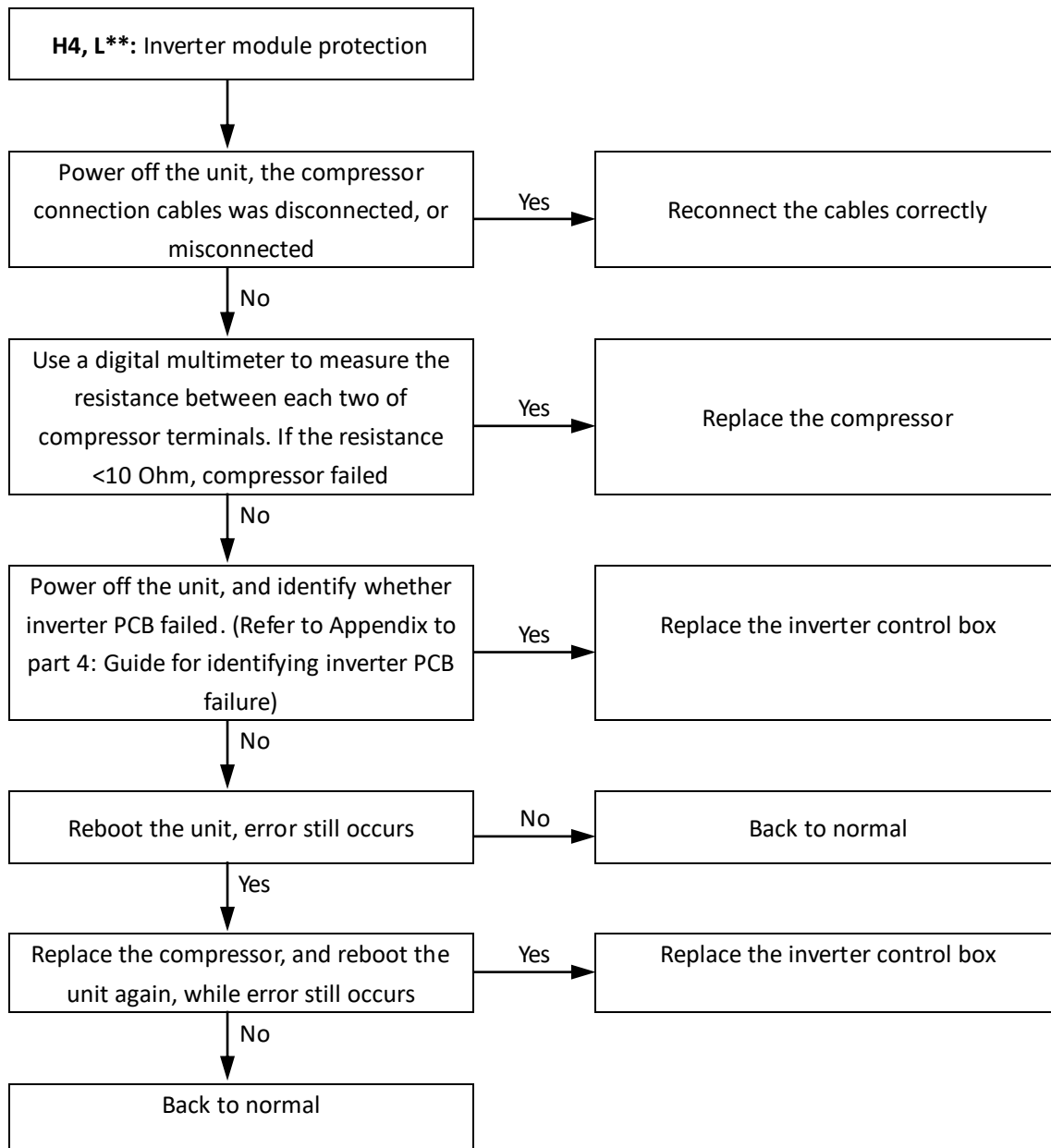

6.25 H6, HH, J** Troubleshooting

6.25.1 Digital display output

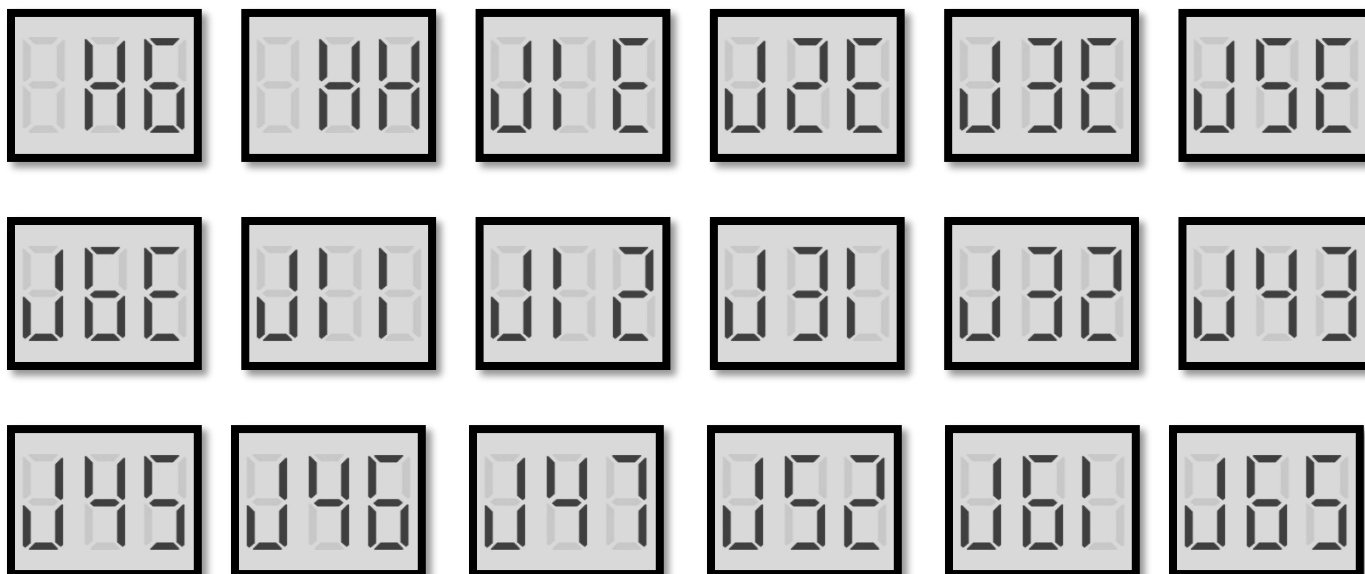

6.25.2 Description

Error code	Description	Note
H6	Fan failure	
HH	10 times of H6 in 120mins	
J**	Fan module failure	Chcek the specific code on digital display panel on the Main Control PCB

The specific J** code table:

Error code	Description
J1E	Hardware overcurrent protection
J11	Phase current instantaneous overcurrent protection
J12	Phase current continuous 30s overcurrent protection
J2E	Over-temperature protection
J3E	Bus voltage too low error
J31	Bus voltage too high error
J32	Bus voltage excessively high error
J43	Abnormal phase current sampling bias
J45	Fan motor code mismatch error
J46	IPM protection (FO)
J47	Module type mismatch (after module resistance tested)
J5E	Motor failed to start
J52	Motor stalling protection
J6E	Phase loss protection
J61	Fan terminals short circuit protection
J65	IPM short circuit protection

6.25.3 Procedure

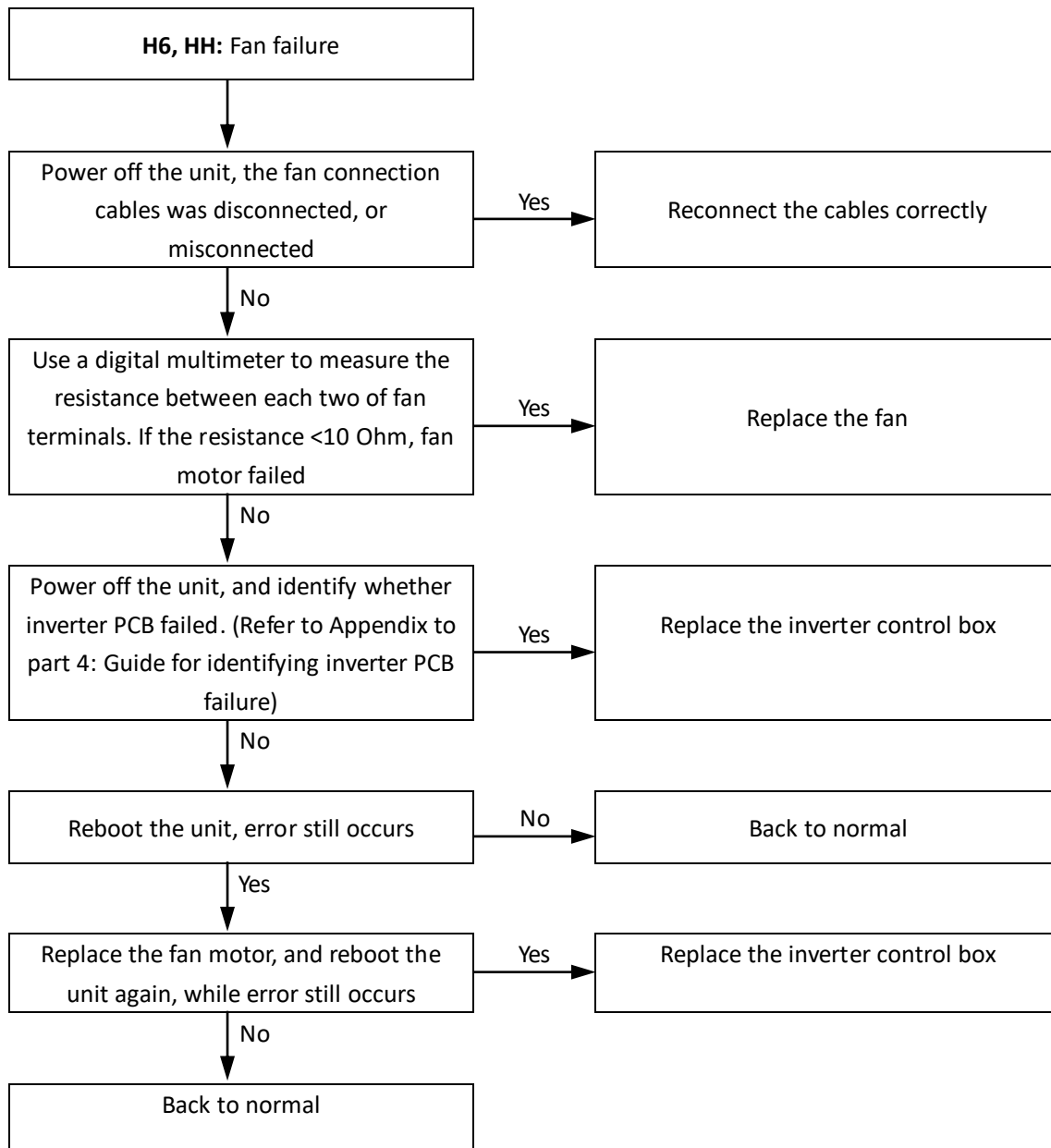

6.26 HF Troubleshooting

6.26.1 Digital display output



6.26.2 Description

Error code		HF
Description		Outdoor unit EEPROM error
Triggering		The driving program of inverter PCB is detected as being mismatched with Dip switch
Relative ports and locations	Dip switch S5 S6	
Correct Dip switch	S5	0/0/0/0
	S6 (4-16kW 1Ph)	0/0/0/1-4kW、0/0/1/0-6kW、0/0/1/1-8kW、0/1/0/0-10kW、0/1/0/1-12kW、0/1/1/0-14kW、0/1/1/1-16kW
	S6 (12-16kW 3Ph)	1/1/0/1-12kW、1/1/1/0-14kW、1/1/1/1-10kW、

6.26.3 Procedure

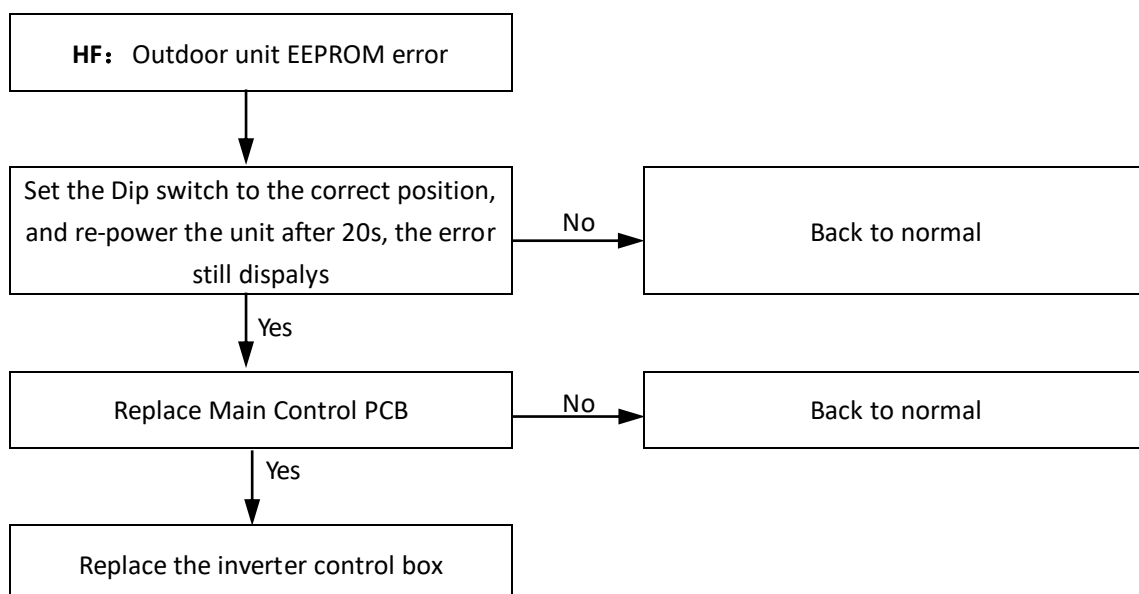

6.27 Pb Troubleshooting

6.27.1 Digital display output

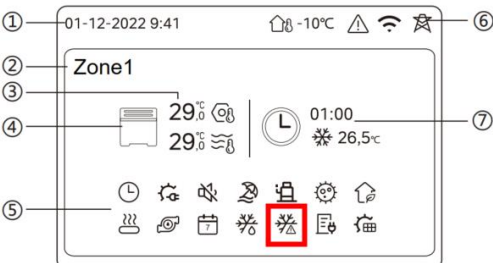

6.27.2 Description

Error code	Pb
Description	Pb is the indicator that shows the system is running in anti-freezing control
Triggering	Refer to Part 3 - Protection control – Anti-freezing protection control
User Interface	 <p>It shows anti-freezing icon on the User Interface</p>

6.28 C2 Troubleshooting

6.28.1 Digital display output

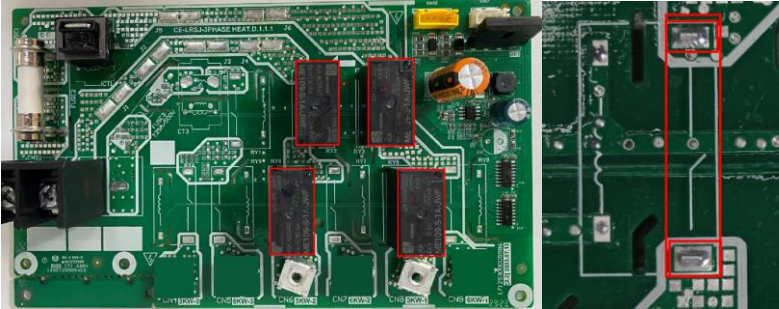

6.28.2 Description

Error code		C2
Description		Relay adhesion on IBH PCB
Triggering		Relay: Poor contact, relay deformation, relay aging, etc. External factors : overcurrent, over high ambient temperature, etc.
Relative ports and locations	Relays and pins of a relay	
	User interface -For Serviceman- C2 restore	<div style="display: flex; justify-content: space-around;"> <div style="border: 1px solid gray; padding: 5px; width: 45%;"> <p style="text-align: center;">For serviceman</p> <p>HMI address setting > </p> <p>Common setting ></p> <p>C2 fault restore ></p> </div> <div style="border: 1px solid gray; padding: 5px; width: 45%;"> <p style="text-align: center;">For serviceman</p> <div style="border: 1px solid gray; padding: 5px; margin-bottom: 5px;"> <p>C2 Fault will berestored. Please confirm IBH PCB has been repaired.</p> </div> <div style="display: flex; justify-content: space-around;"> NO YES </div> </div> </div>

6.28.3 Procedure

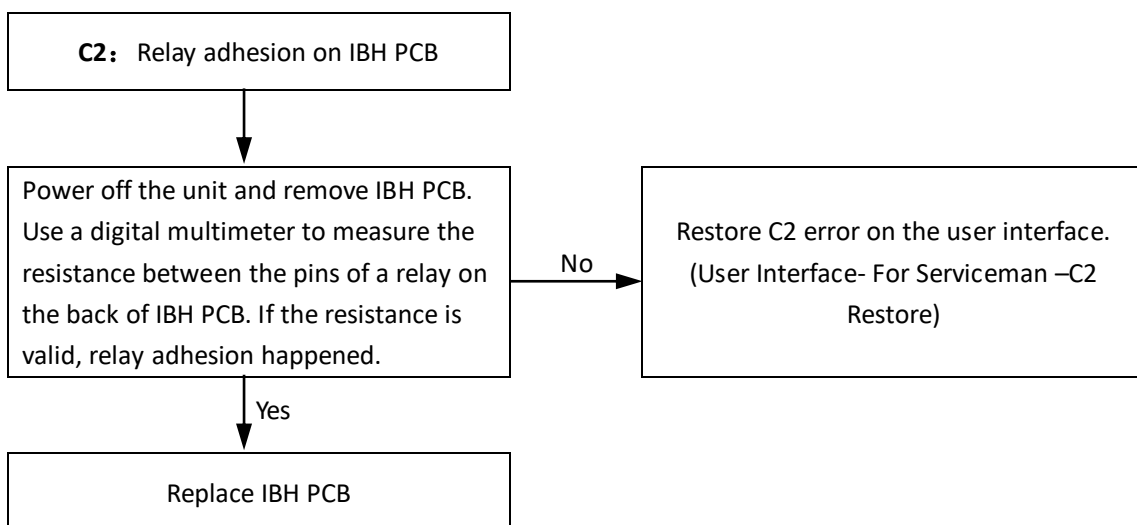





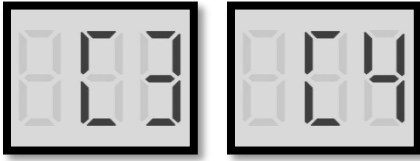



6.29 C3, C4 Troubleshooting

6.29.1 Digital display output

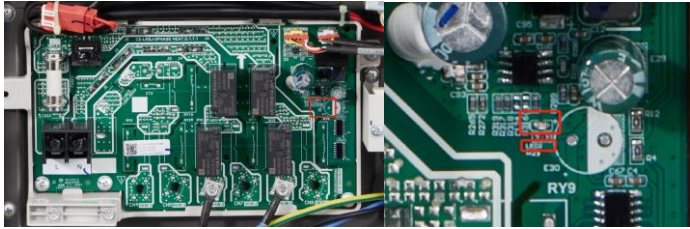
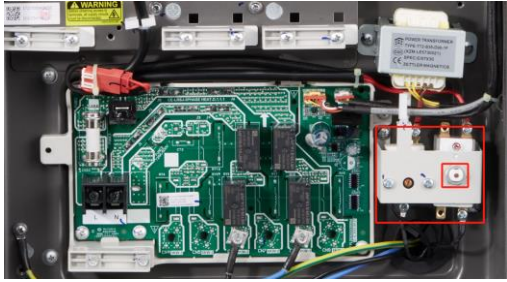
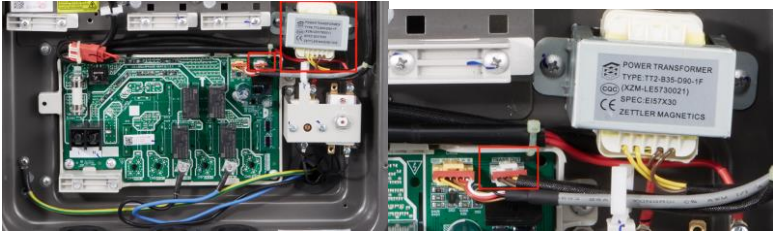

6.29.2 Description

Error code	C3	C4						
Description	Current transformer failure or circuit failure of IBH PCB	C3 ≥ 3 times						
Triggering	Incorrect Dip switch S1, cables with IBH connected improperly; Overvoltage, IBH failure etc.							
Correct Dip switch S1	<div style="text-align: center;"> <p>FACTORY SETTINGS</p> <table border="1" style="margin: auto;"> <tr> <td style="text-align: center;">3kW</td> <td style="text-align: center;">6kW</td> <td style="text-align: center;">9kW</td> </tr> <tr> <td style="text-align: center;"> <p>S1</p>  </td> <td style="text-align: center;"> <p>S1</p>  </td> <td style="text-align: center;"> <p>S1</p>  </td> </tr> </table> </div>		3kW	6kW	9kW	<p>S1</p> 	<p>S1</p> 	<p>S1</p> 
3kW	6kW	9kW						
<p>S1</p> 	<p>S1</p> 	<p>S1</p> 						
IBH PCB LED light								
Temperature controller								
Power transformer And "TRANS OUT" port								

6.29.3 Procedure

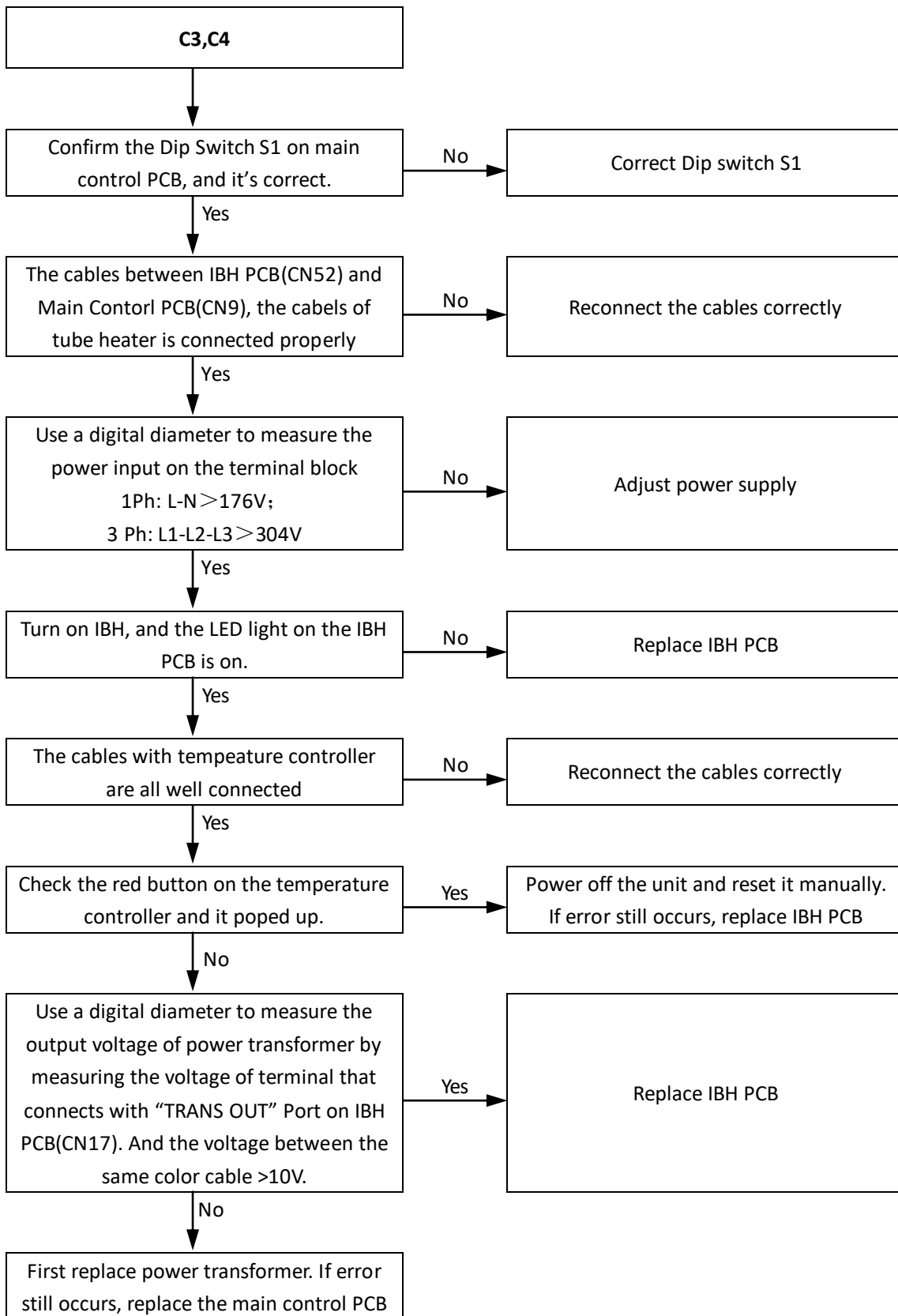

7 Discharge / Suction pressure and temperature range

The following parameter ranges are used to roughly determine whether the system is running properly:

Discharge temperature(Tp) on heating/DHW mode	
$T4 < -10^{\circ}\text{C}$	$Tw_{out}+10 < Tp < Tw_{out}+30$
$-10^{\circ}\text{C} \leq T4 < 10^{\circ}\text{C}$	$Tw_{out}+10 < Tp < Tw_{out}+30$
$10^{\circ}\text{C} \leq T4 < 25^{\circ}\text{C}$	$Tw_{out}+10 < Tp < Tw_{out}+25$
$T4 \geq 25^{\circ}\text{C}$	$Tw_{out}+10 < Tp < Tw_{out}+25$

Note:
T4: ambient temperature
Tw_out: leaving water temperature.

Discharge temperature(Tp) on cooling mode				
Tp 值(°C)	Fx < 44Hz	44Hz ≤ Fx < 62Hz	62Hz ≤ Fx < 72Hz	Fx ≥ 72Hz
$T4 < 25^{\circ}\text{C}$	50 ± 10	55 ± 10	60 ± 10	65 ± 10
$25^{\circ}\text{C} \leq T4 < 30^{\circ}\text{C}$	55 ± 10	60 ± 10	65 ± 10	70 ± 10
$30^{\circ}\text{C} \leq T4 < 35^{\circ}\text{C}$	60 ± 10	65 ± 10	70 ± 10	75 ± 10
$35^{\circ}\text{C} \leq T4 < 40^{\circ}\text{C}$	65 ± 10	70 ± 10	75 ± 10	80 ± 10
$40^{\circ}\text{C} \leq T4 < 46^{\circ}\text{C}$	70 ± 10	75 ± 10	80 ± 10	85 ± 10
$T4 \geq 46^{\circ}\text{C}$	70 ± 10	75 ± 10	80 ± 10	85 ± 10

Note:
T4: ambient temperature
Fx: compressor frequency

Discharge pressure(P1) for heating/DHW mode						
Tw_out(°C)	25	30	35	40	45	50
P1 (kPa)	1000 ± 100	1150 ± 100	1300 ± 100	1450 ± 100	1600 ± 100	1800 ± 100
Tw_out(°C)	55	60	65	70	75	
P1 (kPa)	2000 ± 150	2200 ± 150	2450 ± 150	2700 ± 150	3000 ± 150	

Note: P1 is absolute pressure.

Suction pressure(P2) for cooling mode							
Tw_out(°C)	5~7	8~10	11~13	14~16	17~19	20~22	23~25
P2 (kPa)	520 ± 50	570 ± 50	610 ± 50	670 ± 50	740 ± 50	780 ± 50	830 ± 50

Note: P2 is absolute pressure.

8 Appendix to Part 4

8.1 Temperature Sensor Resistance Characteristics

Applied to							
T3 Outdoor unit heat exchanger bottom temperature sensor							
T4 Ambient temperature sensor							
Th Return-air temperature sensor							
T2 Plate heat exchanger outlet refrigerant temperature sensor							
T2B Plate heat exchanger inlet refrigerant temperature sensor							
TL Outdoor unit heat exchanger outlet temperature sensor							
<i>R25=10K Ω ±3%, B25/50=4100K ±3%</i>							
Temp. (°C)	Resistance (kΩ)			Temp. (°C)	Resistance (kΩ)		
	Rmax	R (t) Normal	Rmin		Rmax	R (t) Normal	Rmin
-40	433.108	383.315	336.854	-8	57.649	53.458	49.492
-39	404.038	358.094	315.212	-7	54.456	50.575	46.899
-38	377.08	334.677	295.088	-6	51.456	47.862	44.455
-37	352.071	312.924	276.365	-5	48.636	45.308	42.15
-36	328.859	292.709	258.939	-4	45.984	42.903	39.977
-35	307.306	273.916	242.714	-3	43.49	40.638	37.927
-34	287.285	256.435	227.599	-2	41.144	38.504	35.992
-33	268.678	240.17	213.514	-1	38.935	36.492	34.165
-32	251.38	225.029	200.382	0	36.857	34.596	32.44
-31	235.291	210.929	188.133	1	34.898	32.807	30.81
-30	220.32	197.792	176.705	2	33.055	31.12	29.271
-29	206.384	185.547	166.037	3	31.317	29.528	27.815
-28	193.407	174.131	156.075	4	29.681	28.026	26.44
-27	181.317	163.481	146.768	5	28.138	26.608	25.14
-26	170.049	153.543	138.071	6	26.682	25.268	23.909
-25	159.543	144.266	129.939	7	25.31	24.003	22.745
-24	149.745	135.601	122.333	8	24.016	22.808	21.644
-23	140.602	127.507	115.216	9	22.794	21.678	20.601
-22	132.067	119.941	108.555	10	21.641	20.61	19.614
-21	124.098	112.867	102.318	11	20.553	19.601	18.68
-20	116.539	106.732	96.92	12	19.525	18.646	17.794
-19	110.231	100.552	91.451	13	18.554	17.743	16.955
-18	103.743	94.769	86.328	14	17.636	16.888	16.16
-17	97.673	89.353	81.525	15	16.769	16.079	15.406
-16	91.99	84.278	77.017	16	15.949	15.313	14.691
-15	86.669	79.521	72.788	17	15.174	14.588	14.014
-14	81.684	75.059	68.815	18	14.442	13.902	13.372
-13	77.013	70.873	65.083	19	13.748	13.251	12.762
-12	72.632	66.943	61.574	20	13.093	12.635	12.183
-11	68.523	63.252	58.274	21	12.471	12.05	11.634
-10	64.668	59.784	55.169	22	11.883	11.496	11.112
-9	61.048	56.524	52.246	23	11.327	10.971	10.617

Continue on next page...

Temp. (°C)	Resistance (kΩ)			Temp. (°C)	Resistance (kΩ)		
	Rmax	R (t) Normal	Rmin		Rmax	R (t) Normal	Rmin
24	10.8	10.473	10.147	66	2.004	1.883	1.766
25	10.3	10	9.7	67	1.934	1.816	1.702
26	9.848	9.551	9.255	68	1.867	1.752	1.641
27	9.418	9.125	8.834	69	1.802	1.69	1.582
28	9.01	8.721	8.434	70	1.74	1.631	1.525
29	8.621	8.337	8.055	71	1.68	1.574	1.471
30	8.252	7.972	7.695	72	1.622	1.519	1.419
31	7.9	7.625	7.353	73	1.567	1.466	1.369
32	7.566	7.296	7.029	74	1.514	1.416	1.321
33	7.247	6.982	6.721	75	1.463	1.367	1.275
34	6.944	6.684	6.428	76	1.414	1.321	1.23
35	6.656	6.401	6.15	77	1.367	1.276	1.188
36	6.381	6.131	5.886	78	1.321	1.233	1.147
37	6.119	5.874	5.634	79	1.277	1.191	1.108
38	5.87	5.63	5.395	80	1.235	1.151	1.07
39	5.631	5.397	5.167	81	1.195	1.113	1.034
40	5.404	5.175	4.951	82	1.156	1.076	0.999
41	5.188	4.964	4.745	83	1.118	1.041	0.966
42	4.982	4.763	4.549	84	1.082	1.007	0.934
43	4.785	4.571	4.362	85	1.047	0.974	0.903
44	4.596	4.387	4.183	86	1.014	0.942	0.874
45	4.417	4.213	4.014	87	0.982	0.912	0.845
46	4.246	4.046	3.851	88	0.951	0.883	0.818
47	4.082	3.887	3.697	89	0.921	0.855	0.791
48	3.925	3.735	3.55	90	0.892	0.828	0.766
49	3.776	3.59	3.409	91	0.864	0.802	0.742
50	3.632	3.451	3.274	92	0.838	0.777	0.719
51	3.495	3.318	3.146	93	0.812	0.753	0.696
52	3.363	3.191	3.023	94	0.787	0.73	0.675
53	3.237	3.069	2.905	95	0.763	0.708	0.654
54	3.116	2.952	2.793	96	0.74	0.686	0.634
55	3.001	2.841	2.685	97	0.718	0.666	0.615
56	2.89	2.734	2.582	98	0.697	0.646	0.597
57	2.784	2.632	2.484	99	0.677	0.627	0.579
58	2.682	2.534	2.39	100	0.657	0.609	0.562
59	2.585	2.44	2.299	101	0.638	0.591	0.546
60	2.491	2.35	2.213	102	0.62	0.574	0.53
61	2.401	2.264	2.13	103	0.602	0.558	0.515
62	2.315	2.181	2.051	104	0.585	0.542	0.501
63	2.233	2.102	1.975	105	0.569	0.527	0.485
64	2.154	2.026	1.903				
65	2.077	1.953	1.833				

End

Applied to
Tp Discharge temperature sensor
R90°C=5KΩ±3%, B25/50=3950K±3%

Temp. (°C)	Resistance (kΩ)			Temp. (°C)	Resistance (kΩ)		
	Rmax	R (t) Normal	Rmin		Rmax	R (t) Normal	Rmin
-40	2002.628	1642.059	1281.49	-8	318.604	271.634	224.664
-39	1881.964	1544.968	1207.972	-7	302.08	257.867	213.653
-38	1769.292	1454.213	1139.134	-6	286.483	244.857	203.232
-37	1664.009	1369.32	1074.631	-5	271.757	232.561	193.365
-36	1565.57	1289.862	1014.154	-4	257.852	220.937	184.022
-35	1473.481	1215.451	957.421	-3	244.717	209.945	175.173
-34	1387.282	1145.725	904.168	-2	232.309	199.55	166.79
-33	1306.554	1080.355	854.156	-1	220.585	189.716	158.848
-32	1230.918	1019.042	807.166	0	209.504	180.412	151.321
-31	1160.015	961.505	762.994	1	199.029	171.607	144.186
-30	1093.521	907.487	721.452	2	189.125	163.273	137.422
-29	1031.137	856.752	682.368	3	179.759	155.383	131.007
-28	972.588	809.086	645.583	4	170.899	147.911	124.923
-27	917.615	764.281	610.947	5	162.517	140.835	119.152
-26	865.981	722.152	578.323	6	154.585	134.13	113.675
-25	817.469	682.528	547.586	7	147.077	127.778	108.478
-24	771.875	645.245	518.616	8	139.97	121.757	103.544
-23	729.009	610.156	491.303	9	133.239	116.049	98.859
-22	688.698	577.121	465.544	10	126.864	110.638	94.411
-21	650.778	546.012	441.246	11	120.825	105.505	90.185
-20	615.097	516.708	418.318	12	115.103	100.636	86.17
-19	581.515	489.096	396.678	13	109.679	96.017	82.354
-18	549.899	463.073	376.247	14	104.537	91.633	78.728
-17	520.129	438.542	356.955	15	99.662	87.471	75.28
-16	492.089	415.411	338.733	16	95.038	83.52	72.001
-15	465.672	393.595	321.518	17	90.652	79.767	68.882
-14	440.779	373.014	305.25	18	86.489	76.202	65.915
-13	417.316	353.595	289.874	19	82.539	72.815	63.091
-12	395.197	335.268	275.339	20	78.789	69.596	60.404
-11	374.34	317.967	261.594	21	75.228	66.537	57.845
-10	354.669	301.632	248.595	22	71.846	63.627	55.409
-9	336.113	286.206	236.298	23	68.633	60.86	53.088

Continue on next page...

Temp. (°C)	Resistance (kΩ)			Temp. (°C)	Resistance (kΩ)		
	Rmax	R (t) Normal	Rmin		Rmax	R (t) Normal	Rmin
24	65.58	58.228	50.877	66	11.858	11.134	10.411
25	62.678	55.724	48.77	67	11.432	10.749	10.066
26	59.919	53.34	46.762	68	11.024	10.38	9.735
27	57.295	51.071	44.847	69	10.632	10.024	9.416
28	54.8	48.91	43.021	70	10.255	9.682	9.109
29	52.426	46.853	41.279	71	9.894	9.354	8.814
30	50.167	44.892	39.617	72	9.546	9.038	8.53
31	48.016	43.024	38.031	73	9.213	8.734	8.255
32	45.969	41.243	36.517	74	8.892	8.442	7.992
33	44.019	39.546	35.072	75	8.584	8.161	7.737
34	42.162	37.927	33.692	76	8.288	7.89	7.492
35	40.392	36.383	32.373	77	8.003	7.629	7.256
36	38.706	34.91	31.113	78	7.729	7.379	7.028
37	37.098	33.504	29.909	79	7.466	7.137	6.809
38	35.566	32.162	28.758	80	7.213	6.905	6.597
39	34.104	30.881	27.657	81	6.969	6.681	6.393
40	32.709	29.657	26.605	82	6.735	6.466	6.196
41	31.379	28.488	25.598	83	6.509	6.258	6.006
42	30.109	27.372	24.634	84	6.292	6.058	5.823
43	28.896	26.304	23.712	85	6.084	5.865	5.646
44	27.739	25.284	22.829	86	5.883	5.679	5.476
45	26.633	24.309	21.984	87	5.689	5.5	5.311
46	25.577	23.376	21.174	88	5.502	5.327	5.152
47	24.568	22.483	20.399	89	5.323	5.161	4.998
48	23.603	21.629	19.656	90	5.15	5	4.85
49	22.681	20.812	18.943	91	4.996	4.845	4.694
50	21.799	20.03	18.261	92	4.847	4.696	4.545
51	20.956	19.281	17.606	93	4.703	4.552	4.4
52	20.149	18.563	16.978	94	4.564	4.412	4.261
53	19.377	17.876	16.375	95	4.43	4.278	4.127
54	18.638	17.218	15.797	96	4.3	4.149	3.997
55	17.931	16.587	15.243	97	4.175	4.024	3.872
56	17.254	15.982	14.71	98	4.054	3.903	3.752
57	16.606	15.402	14.199	99	3.937	3.787	3.636
58	15.984	14.846	13.708	100	3.824	3.674	3.524
59	15.389	14.313	13.236	101	3.715	3.565	3.416
60	14.819	13.801	12.783	102	3.609	3.46	3.312
61	14.272	13.31	12.348	103	3.507	3.359	3.211
62	13.748	12.839	11.929	104	3.409	3.261	3.114
63	13.246	12.387	11.527	105	3.313	3.167	3.02
64	12.764	11.952	11.14	106	3.221	3.075	2.929
65	12.302	11.535	10.768	107	3.131	2.987	2.842

Continue on next page...

Temp. (°C)	Resistance (kΩ)			Temp. (°C)	Resistance (kΩ)		
	Rmax	R (t) Normal	Rmin		Rmax	R (t) Normal	Rmin
108	3.045	2.901	2.758	132	1.625	1.511	1.397
109	2.962	2.819	2.676	133	1.586	1.473	1.36
110	2.881	2.739	2.597	134	1.548	1.436	1.324
111	2.802	2.662	2.521	135	1.511	1.401	1.29
112	2.727	2.587	2.448	136	1.475	1.366	1.257
113	2.653	2.515	2.377	137	1.44	1.332	1.225
114	2.582	2.445	2.308	138	1.407	1.3	1.193
115	2.514	2.378	2.242	139	1.374	1.268	1.163
116	2.447	2.313	2.178	140	1.342	1.238	1.133
117	2.383	2.249	2.116	141	1.311	1.208	1.105
118	2.32	2.188	2.056	142	1.281	1.179	1.077
119	2.26	2.129	1.998	143	1.252	1.151	1.051
120	2.201	2.072	1.942	144	1.224	1.124	1.024
121	2.145	2.016	1.888	145	1.196	1.098	0.999
122	2.09	1.963	1.836	146	1.169	1.072	0.975
123	2.037	1.911	1.785	147	1.143	1.047	0.951
124	1.985	1.86	1.736	148	1.118	1.023	0.928
125	1.935	1.812	1.689	149	1.093	0.999	0.905
126	1.887	1.765	1.643	150	1.069	0.977	0.884
127	1.84	1.719	1.598				
128	1.794	1.675	1.555				
129	1.75	1.632	1.514				
130	1.707	1.59	1.473				
131	1.665	1.55	1.434				

End

Applied to

TW_in Plate heat exchanger inlet watertemperature sensor

TW_out Plate heat exchanger outlet water temperature sensor

T5 Water tank temperature sensor

TW2 Zone 2 water flow temperature sensor

R50=17.6KΩ±3%, B0/100=3970K±2%

Temp. (°C)	Resistance (kΩ)			Temp. (°C)	Resistance (kΩ)		
	Rmax	R (t) Normal	Rmin		Rmax	R (t) Normal	Rmin
-40	1822.916	1608.351	1393.786	-8	263.273	242.131	220.989
-39	1705.939	1507.271	1308.602	-7	249.357	229.593	209.828
-38	1596.976	1412.994	1229.013	-6	236.255	217.774	199.293
-37	1495.47	1325.058	1154.647	-5	223.915	206.63	189.345
-36	1400.897	1243.025	1085.152	-4	212.289	196.119	179.949
-35	1312.771	1166.486	1020.2	-3	201.332	186.201	171.07
-34	1230.637	1095.061	959.485	-2	191.001	176.84	162.678
-33	1154.07	1028.393	902.717	-1	181.258	168.001	154.744
-32	1082.675	966.151	849.626	0	172.066	159.653	147.24
-31	1016.084	908.023	799.962	1	163.391	151.766	140.141
-30	953.957	853.724	753.491	2	155.2	144.311	133.422
-29	896.053	802.986	709.918	3	147.466	137.264	127.062
-28	842.002	755.557	669.113	4	140.159	130.599	121.038
-27	791.53	711.21	630.889	5	133.253	124.293	115.332
-26	744.384	669.728	595.072	6	126.725	118.326	109.926
-25	700.328	630.913	561.498	7	120.554	112.679	104.803
-24	659.144	594.58	530.015	8	114.715	107.33	99.945
-23	620.629	560.556	500.483	9	109.191	102.265	95.338
-22	584.595	528.683	472.771	10	103.963	97.466	90.969
-21	550.871	498.814	446.757	11	99.013	92.918	86.822
-20	519.295	470.812	422.328	12	94.327	88.607	82.888
-19	489.718	444.548	399.379	13	89.887	84.519	79.152
-18	462.003	419.907	377.812	14	85.679	80.642	75.604
-17	436.022	396.779	357.537	15	81.692	76.963	72.234
-16	411.657	375.063	338.468	16	77.911	73.471	69.032
-15	388.797	354.662	320.527	17	74.326	70.157	65.989
-14	367.343	335.492	303.641	18	70.925	67.011	63.097
-13	347.198	317.47	287.743	19	67.699	64.023	60.347
-12	328.275	300.521	272.767	20	64.636	61.184	57.731
-11	310.495	284.576	258.658	21	61.729	58.486	55.243
-10	293.78	269.569	245.359	22	58.967	55.921	52.875
-9	278.06	255.439	232.818	23	56.345	53.483	50.621

Continue on next page...

Temp. (°C)	Resistance (kΩ)			Temp. (°C)	Resistance (kΩ)		
	Rmax	R (t) Normal	Rmin		Rmax	R (t) Normal	Rmin
24	53.854	51.165	48.476	66	10.231	9.818	9.405
25	51.485	48.959	46.432	67	9.887	9.481	9.075
26	49.234	46.86	44.486	68	9.556	9.157	8.758
27	47.094	44.863	42.632	69	9.237	8.846	8.454
28	45.058	42.961	40.865	70	8.932	8.547	8.163
29	43.121	41.151	39.181	71	8.637	8.259	7.882
30	41.278	39.427	37.575	72	8.354	7.983	7.613
31	39.524	37.784	36.044	73	8.08	7.717	7.354
32	37.854	36.219	34.583	74	7.818	7.461	7.105
33	36.263	34.726	33.189	75	7.565	7.215	6.866
34	34.748	33.304	31.86	76	7.322	6.978	6.635
35	33.305	31.947	30.59	77	7.087	6.75	6.414
36	31.929	30.653	29.378	78	6.861	6.531	6.201
37	30.617	29.419	28.22	79	6.643	6.319	5.995
38	29.367	28.241	27.114	80	6.433	6.115	5.798
39	28.174	27.115	26.057	81	6.23	5.919	5.608
40	27.036	26.042	25.048	82	6.035	5.73	5.425
41	25.949	25.015	24.082	83	5.847	5.548	5.249
42	24.913	24.036	23.159	84	5.666	5.372	5.079
43	23.924	23.1	22.276	85	5.491	5.204	4.916
44	22.979	22.206	21.432	86	5.323	5.041	4.759
45	22.076	21.35	20.624	87	5.16	4.884	4.608
46	21.213	20.532	19.85	88	5.003	4.732	4.462
47	20.389	19.749	19.11	89	4.852	4.587	4.322
48	19.602	19.001	18.401	90	4.706	4.446	4.186
49	18.848	18.285	17.722	91	4.565	4.31	4.056
50	18.128	17.6	17.072	92	4.429	4.179	3.929
51	17.466	16.944	16.422	93	4.298	4.053	3.809
52	16.831	16.316	15.801	94	4.172	3.932	3.692
53	16.223	15.714	15.206	95	4.049	3.814	3.579
54	15.641	15.139	14.638	96	3.932	3.701	3.471
55	15.081	14.586	14.092	97	3.817	3.591	3.365
56	14.545	14.058	13.571	98	3.708	3.486	3.265
57	14.03	13.55	13.07	99	3.601	3.384	3.167
58	13.537	13.064	12.591	100	3.499	3.286	3.073
59	13.063	12.597	12.132	101	3.4	3.191	2.983
60	12.608	12.15	11.692	102	3.303	3.098	2.894
61	12.171	11.721	11.27	103	3.21	3.009	2.809
62	11.752	11.309	10.866	104	3.12	2.923	2.727
63	11.349	10.913	10.478	105	3.032	2.84	2.647
64	10.962	10.533	10.105	106	2.948	2.759	2.571
65	10.589	10.168	9.748	107	2.866	2.681	2.497

Continue on next page...

Temp. (°C)	Resistance (kΩ)			Temp. (°C)	Resistance (kΩ)		
	Rmax	R (t) Normal	Rmin		Rmax	R (t) Normal	Rmin
108	2.787	2.606	2.425	132	1.477	1.364	1.251
109	2.711	2.533	2.356	133	1.44	1.329	1.219
110	2.637	2.463	2.288	134	1.405	1.296	1.187
111	2.565	2.394	2.224	135	1.37	1.264	1.157
112	2.496	2.328	2.161	136	1.337	1.232	1.127
113	2.428	2.264	2.1	137	1.304	1.202	1.099
114	2.363	2.202	2.041	138	1.273	1.172	1.071
115	2.3	2.142	1.985	139	1.242	1.143	1.044
116	2.239	2.084	1.93	140	1.212	1.115	1.018
117	2.179	2.028	1.876	141	1.183	1.088	0.993
118	2.122	1.973	1.825	142	1.155	1.061	0.968
119	2.066	1.92	1.775	143	1.127	1.036	0.944
120	2.012	1.869	1.726	144	1.101	1.011	0.921
121	1.96	1.82	1.68	145	1.075	0.986	0.898
122	1.909	1.772	1.634	146	1.05	0.963	0.876
123	1.86	1.725	1.59	147	1.025	0.94	0.855
124	1.812	1.68	1.548	148	1.001	0.918	0.834
125	1.765	1.636	1.506	149	0.978	0.896	0.814
126	1.72	1.593	1.466	150	0.955	0.875	0.794
127	1.677	1.552	1.428				
128	1.634	1.512	1.39				
129	1.593	1.473	1.354				
130	1.553	1.436	1.318				
131	1.515	1.399	1.284				

End

8.2 Pressure and Output voltage characteristics of Pressure sensor

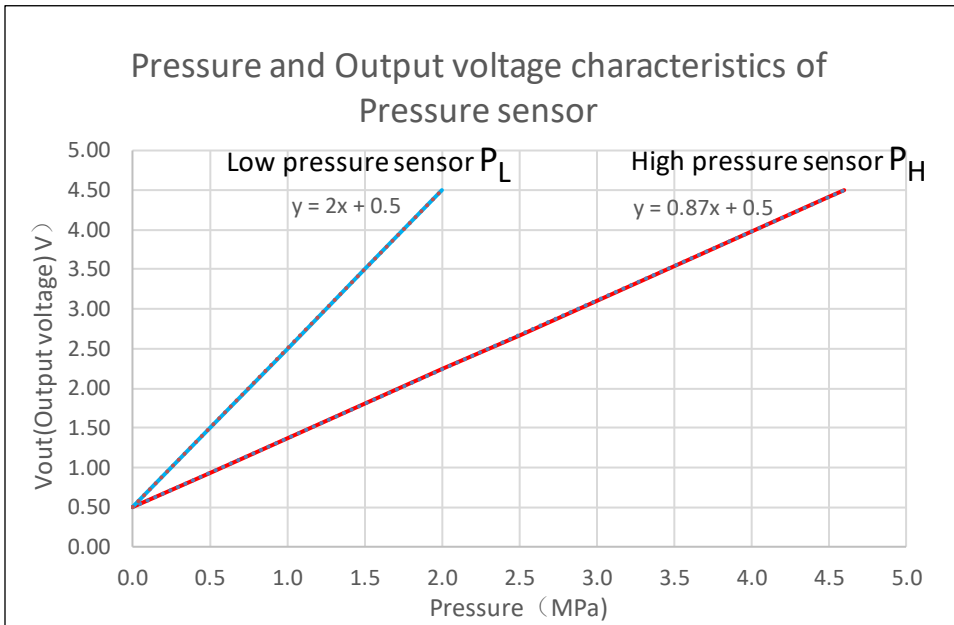

Output voltage formula of high pressure sensor: $V_{out}(H)=0.87 \times P_H+0.5$

Output voltage formula of low pressure sensor: $V_{out}(L)=2 \times P_L+0.5$

Measure the output voltage of pressure sensor

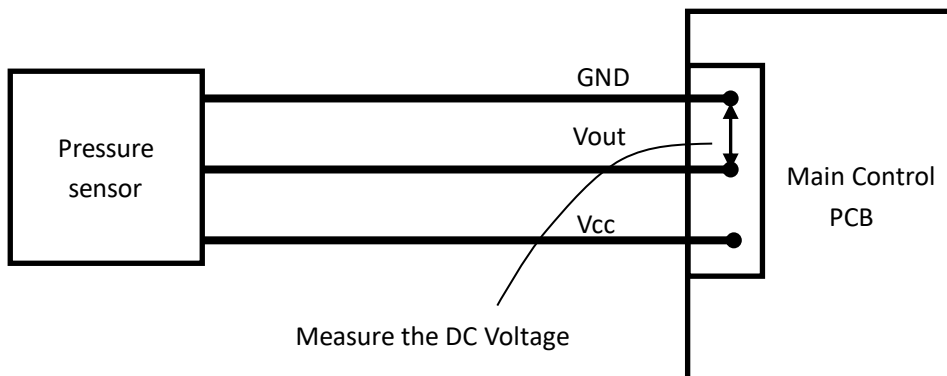

8.3 Guide for identifying inverter PCB failure

Before measuring the inverter PCB, please confirm steps below in advance :

- 1) Cut off the power supply ;
- 2) Wait for 10 mins for capacitor discharging in order to avoid the electric shock
- 3) Remove all connections wires
- 4) To identify whether inverter PCB of 1Ph models failed, follow the guide to test inverter circuit. If any one of test value abnormal, the 1 Ph inverter PCB failed.

To identify whether inverter PCB of 3Ph models failed, follow the guide to test inverter circuit and three phase bridge rectifier. If any one of test value abnormal, the 3 Ph inverter PCB failed.

Preparing tools : multimeter (secondary tube is available)

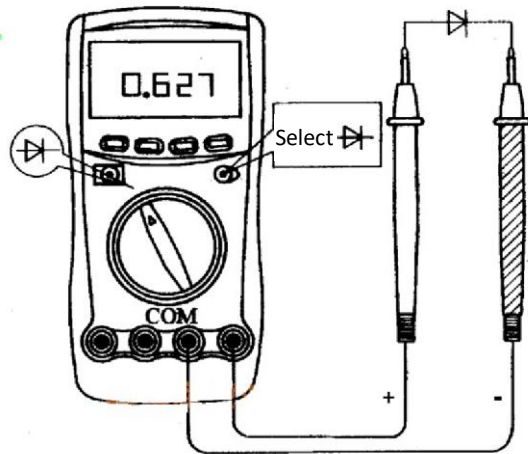

Inverter circuit (Fan module/ Compressor module):

Order	Test point		Normal	Abnormal
	+(Red)	- (Black)		
1	U	P	0.3-0.7V	0 /infinite
2	V	P		
3	W	P		
4	N	U		
5	N	V		
6	N	W		

Note:

1. If any one of test value abnormal, the inverter PCB failed. Request aftersales service and replace the inverter control box.

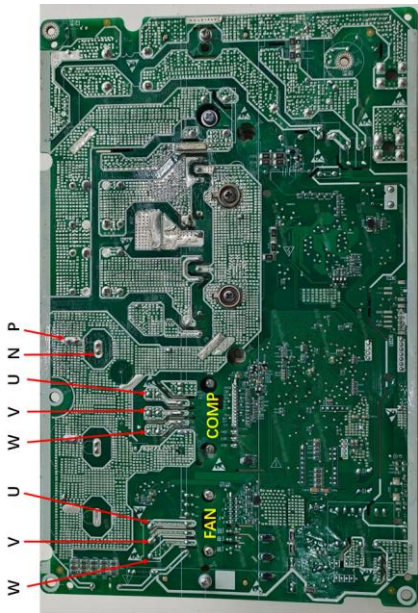

4-10kW
CL45220-CL45221-CL45222-CL45223

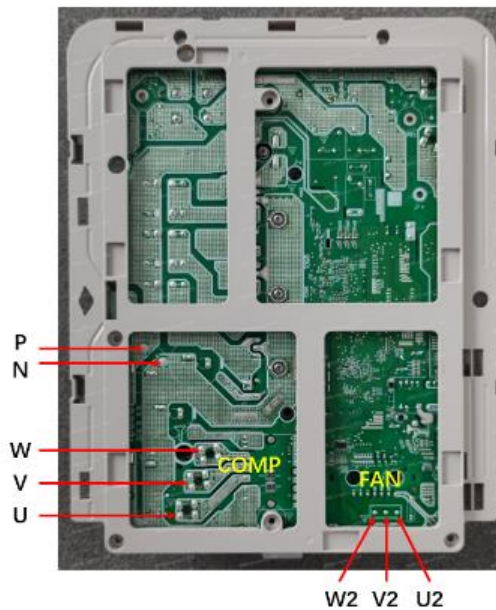

1Ph 12-16kW
CL45224-CL45225-CL45226

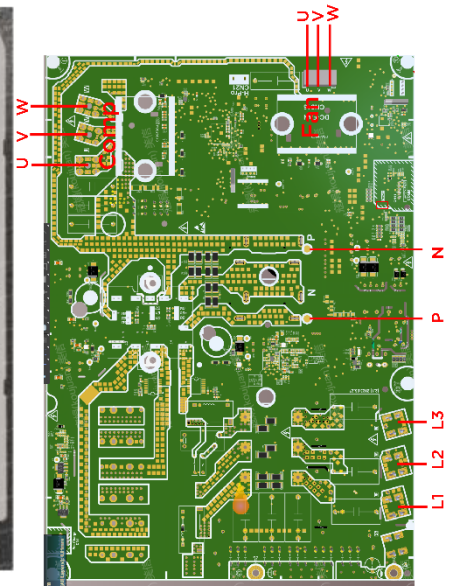

3Ph 12-16kW
CL45227-CL45228-CL45229

Three phase bridge rectifier:

Order	Test point		Normal	Abnormal
	+(Red)	- (Black)		
1	L1	P	0.3-0.7V	0 /infinite
2	L2	P		
3	L3	P		
4	N	L1		
5	N	L2		
6	N	L3		

Note:

If any one of test value is abnormal, the inverter PCB failed. Request aftersales service and replace the inverter control box.

MUNDO  CLIMA®



SALVADOR ESCODA S.A.U.
ROSSELLÓ 430-432
08025 BARCELONA
ESPAÑA / SPAIN
www.mundoclima.com